





The Power of Eaton



EATON
Powering Business Worldwide

There's a certain energy at Eaton. It's the power of integrating the competencies of some of the world's most respected names to build a brand you can trust to meet every power management need. The energy created supports our commitment to powering business worldwide.

As the world's demand increases for high-efficiency hydraulic systems for mobile and stationary applications, Eaton is helping to solve these challenges more reliably, efficiently, and sustainably. Our goal is simple; to provide unique solutions across a wide range of markets that keep businesses on the leading edge of change. Visit Eaton.com/hydraulics/fusion.

That's the power of Eaton.

Serving eight key segments - sharing one focus



Alternative Energy

Making energy sources technically practical and economically sound requires the kind of control made possible by high-quality components. When Eaton is on the inside, you will experience the reliable, consistent performance to create and capture energy—making renewable energy an every-day energy.



Agriculture & Forestry

There's a reason farming and forestry are called "working the land." These segments involve some of the hardest work and longest hours of any sector in the economy. Your productivity and profitability depend on the way you manage time and tasks.



Discrete Manufacturing

Produce at peak efficiency with the superior precision and repeatability of Eaton products. Eaton hydraulic components provide the precise control and consistent operation required for virtually every step in your manufacturing operation. With Eaton, we'll help you redefine the meaning of raw productivity.



Commercial Vehicles

Eaton technologies can make your driving operation more successful. Greater comfort and productivity help increase driver retention, while reduced emissions, leaks, and noise improve environmental performance. Increased efficiencies overall mean lower costs and higher net revenue.



Oil & Gas

As the oil & gas industry continues to face further globalization and consolidation, large-scale organizations that can meet your needs in every corner of the world are more difficult to find. At Eaton, our portfolio of products is only surpassed by our tremendous reach.



Material Handling

Eaton hydraulic systems provide the precise control and consistent operation required for material handling and utility work. With a broad selection of products and solutions built in, Eaton helps make you a master of your domain.



Processing

Whatever your industry, no matter which processes you manage, Eaton parts and systems help keep you up and running. Our components make equipment more efficient and easier to use, so you get optimal machine performance and maximum productivity.



Construction & Mining

When you work on a large scale, even the details are big. You need to trust every part of the equipment that lets you handle construction and mining jobs. For reliable components that deliver consistent performance in extreme conditions, turn to Eaton.

Eaton is a leading diversified power management company

Eaton provides reliable, efficient and safe power management for a growing number of industries.

Understanding and helping our customers succeed

- Listening and understanding to requirements and business drivers
- Delivering solutions with value propositions to solve the critical business needs

Knowing what's important to our customers and integrating that knowledge into the fabric of our business

- ...to deliver innovative, quality products
- ...to respond fast
- ...to provide dedicated customer service and support around the globe

Our strength is global reach with local responsiveness and support

- Customers served in more than 150 countries
- Diverse channels ensure reliable availability and support
- Design and engineering teams provide support for standard products and custom solutions
- Eaton experts offer efficient product and application training

Table of Contents

Advantages of using Eaton Swivel Joints	4
Selection Criteria and Product Safety Considerations	5
FS6500	6
BD5500	12
Repair Kit	15
FS5900	16
Repair Kit	18

Swivel Joints

Advantages of using Eaton Swivel Joints

1. Better System Plumbing:

- Less hose is needed when swivel joints are used, the system is more space efficient (Figure 1).
- Can eliminate the need for tubing configurations to accommodate 90° and other angles.
- Can be directly connected to hose lines frequently eliminating the need for adapters.

2. Prevent Hose Twisting and Kinking:

The swivel action swivel joints prevent hose twisting and kinking (Figure 2 & 3).

3. Less Downtime:

The problem of hose twisting and kinking is eliminated and hose line replacement becomes significantly less.

4. Absorb System Shock:

Swivel joints are not rigid and therefore capable of absorbing some hose shortening when the system is pressurized.

5. Cost Savings:

Less hose, fewer adapters and tubing configurations and less downtime add up to saving money when swivel joints are used.

Features:

- Balanced-pressure design
- Low-drop dimensions
- Contamination seals
- 360° rotation
- Standard O-ring design

Benefits:

- Show no significant increase in torque with introduction of pressure
- Fit in compact areas
- Prevent environmental contaminants from entering the swivel joints
- Prevent hose twisting, thus increasing hose life
- Allow quick and reliable field repairs

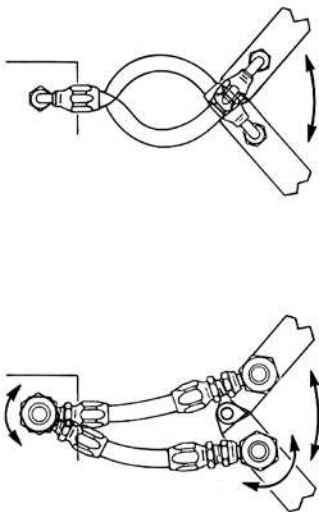

Figure 1

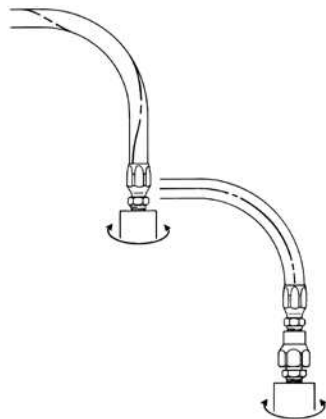

Figure 2

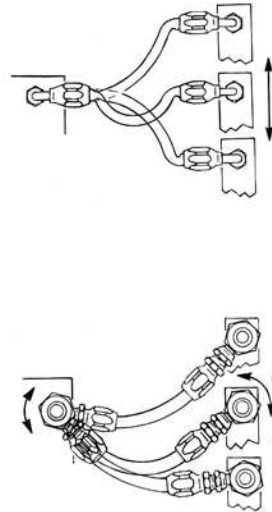

Figure 3

Swivel Joints

Selection Criteria and Product Safety Considerations

Many variables are involved in the application and selection of industrial swivel joints in a fluid power system. Careful consideration must be paid to each of the criteria listed below to achieve optimum efficiency from a swivel joint.

1. Pressure:

This is a force or thrust applied on the surface of a fluid carrying vehicle. System operating pressure must not exceed the rating of the swivel joint.

2. Temperature:

Both internal and ambient temperatures are important in proper swivel joint functioning. Internally, the temperature rating is determined by the seals. If the fluid is too hot, the seals will deteriorate and the swivel joint will leak and resist rotation. Externally, too high a temperature will damage the casing and seals causing similar problems. When selecting seals, always insure they meet the required temperature ranges.

3. Fluid Compatibility:

An important consideration in determining which joint and seal material to use is their compatibility with the agent to be conveyed in the system. Internal swivel joint components that are not suitable for the fluid being carried in the system will be severely damaged. Carefully check the fluid compatibility.

4. Cost:

Cost, of course, is an important consideration. However, the initial cost of a swivel joint can be more than offset by cost reduction benefits such as an improved system routing with less hose, fewer adapters and tube fittings and longer service life.

5. Side Loading:

Defined as the stress caused by angular deflection in a piping system, side loading causes excessive wear on the bearing surfaces and inhibits smooth swivel joint operation. Care must be taken when plumbing a system with swivel joints to avoid stress situations.

6. Pressure Drop:

This is the resistance to the flow of the agent through the swivel joint measured in pounds per square inch (PSI). The higher the resistance to flow, the greater the loss of efficiency. Eaton swivel joints have been designed for minimal resistance to flow.

7. Torque:

Defined as the force that produces a rotation, torque is an important consideration when specifying swivel joints. This permits consistent, trouble-free service.

8. Configurations:

The swivel joint configuration specified (straight or 90°) is determined by such factors as available space and system routing. Make sure the swivel joint configuration and envelope dimensions allow freedom of movement while maintaining compatibility with the system's routing.

9. Port Size:

Using the right port size and thread is a significant factor in the proper selection of a swivel joint. The port size and thread must match that of the end fitting on the connecting hose line.

10. Corrosion Resistance:

Make sure the environment in which the swivel joint works and the fluid carried are free of corrosive elements which could severely limit service life.

11. Rotation:

Rotation must be easy and unrestricted for proper service of the swivel joint. The joint and the connecting line must be allowed to rotate freely for optimum performance.

Swivel Joints FS6500

FS65 Balanced-Pressure Series Swivel Joints answer customer requests for a more cost competitive, compact product.

FS65 Series Swivel Joints feature compact forged casings. Their balanced-pressure design distributes pressure evenly through the body of the joints, eliminating axial loading of the sleeve. This allows the swivel joints to rotate with very low torque—even up to their fully rated operating pressure.

The FS65 is available in sizes 1/4 - inch to 1 - inch. The swivel joints have pressure capabilities up to 5,000 PSI for the 1/4-inch and 3/8-inch sizes; 3,500 PSI for the 1/2-inch, 5/8-inch, and 3/4-inch sizes; and 3,000 PSI for the 1-inch size.

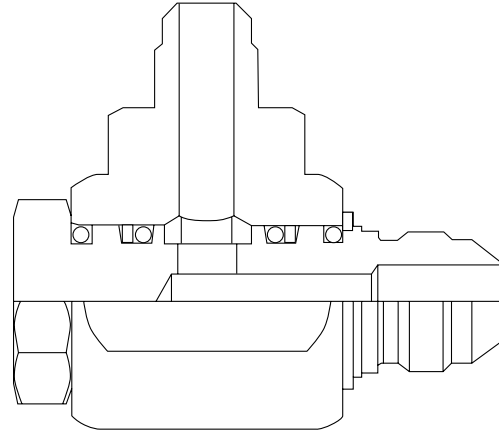

How to Order

When ordering a swivel joint, follow these steps:

1. State the base part number, casing and sleeve port size, as shown.
2. Add the suffix code which indicates the seal required, as shown in the seal chart at right.

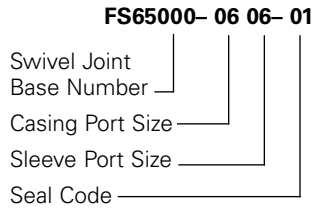

Seal Material Options

Seal Code	Material	Description	Application
-01	Buna-N	O-Ring Seal	Hydraulic Oils, Water, Glycol
-04	EPR	O-Ring Seal	Brake Fluids, Water, Phosphate Ester, Alcohols
-06	Flourocarbon	O-Ring Seal	Chemicals, Gasoline, Aromatic Solvents

Torque vs. Pressure

FS65 Series Swivel Joints perform best in class when it comes to side-load testing, while impulsing at 133 percent of maximum operating pressure—and rotating through a 120-degree angular sweep forward and in reverse.

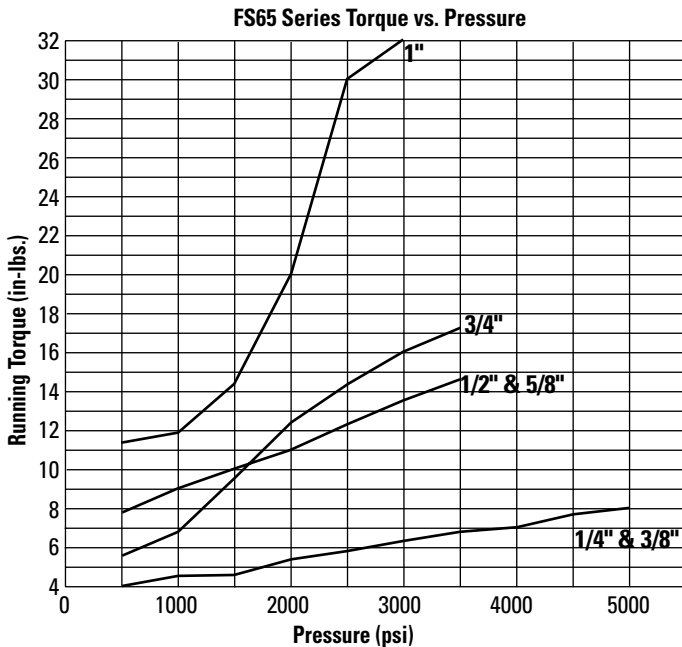

Pressure Drop vs. Flow

FS65 Series Swivel Joints passed the minimum requirements of 150,000 cycles for the 1/4-inch and 3/8-inch nominal sizes, and 200,000 cycles for the 1/2-inch through 1-inch sizes, while measuring zero leakage per SAE J1176.

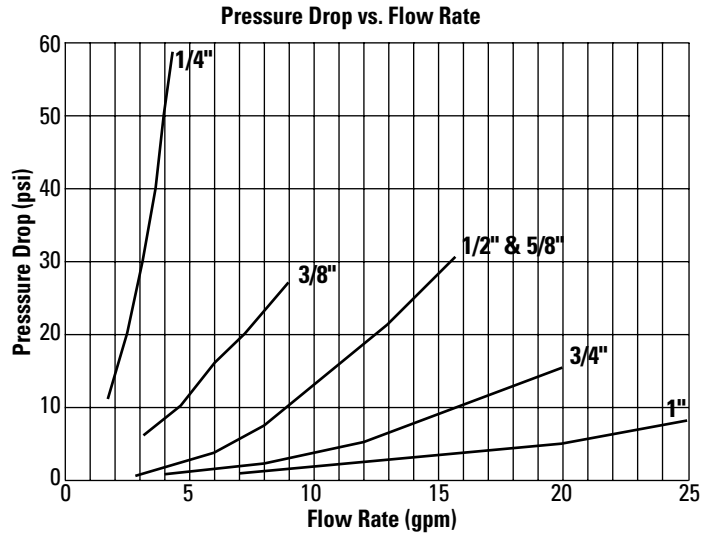

Pressure Rating for FS65 Series

Swivel Size	Operating Pressure (psi)	Swivel Size	Operating Pressure (psi)
1/4"	5000	5/8"	3500
3/8"	5000	3/4"	3500
1/2"	3500	1"	3000

Swivel Joints FS6500

Male Pipe x Female Pipe

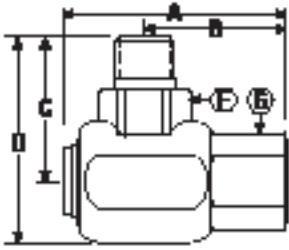

Part Number	Swivel Size	Casing Thread	Sleeve Thread	A	B	C	D	F	G
FS65015-0404-01	1/4	1/4-18 NPTF	1/4-18 NPTF	2.49	1.59	1.66	2.35	24 mm	15/16
FS65015-0808-01	1/2	1/2-14 NPTF	1/2-14 NPTF	3.14	1.97	1.62	2.39	29 mm	1-1/16
FS65015-1616-01	1	1-11 1/2 NPTF	1-11 1/2 NPTF	3.84	2.53	2.60	3.68	43 mm	1-5/8

Male Pipe x Male SAE 37°

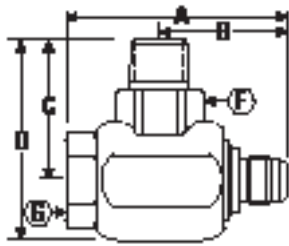

Part Number	Swivel Size	Casing Thread	Sleeve Thread	A	B	C	D	F	G
FS65019-1616-01	1	1-11 1/2 NPTF	1 5/16-12 UN-2A	3.86	2.23	2.60	3.68	43 mm	1-5/8

Male Pipe x Male SAE O-Ring Boss

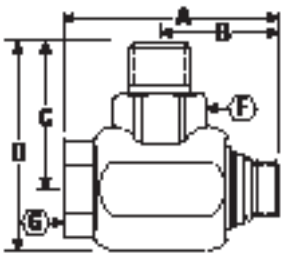

Part Number	Swivel Size	Casing Thread	Sleeve Thread	A	B	C	D	F	G
FS65022-1616-01	1	1-11 1/2 NPTF	1 5/16-12 UN-2A	3.67	2.35	2.60	3.68	43 mm	1-5/8

Female Pipe Swivel (NPSM) x Male Pipe

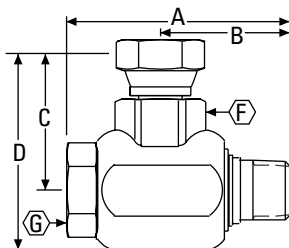

Part Number	Swivel Size	Casing Thread	Sleeve Thread	A	B	C	D	F	G
FS65000-0404-01	1/4	1/4-18 NPSM	1/4-18 NPTF	2.60	1.49	1.45	2.14	24 mm	15/16
FS65000-0606-01	3/8	3/8-18 NPSM	3/8-18 NPTF	2.53	1.48	1.45	2.14	24 mm	15/16
FS65000-0808-01	1/2	1/2-14 NPSM	1/2-14 NPTF	2.88	1.54	1.62	2.39	29 mm	1
FS65000-1212-01	3/4	3/4-14 NPSM	3/4-14 NPTF	3.21	1.89	2.14	3.09	34 mm	1-1/4
FS65000-1616-01	1	1-11 1/2 NPSM	1-11 1/2 NPTF	3.91	2.27	2.40	3.48	43 mm	1-5/8

*Special order only.

Swivel Joints FS6500

Female Pipe Swivel (NPSM) x Male SAE 37°

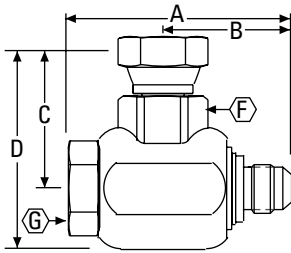

Part Number	Swivel Size	Casing Thread	Sleeve Thread	A	B	C	D	F	G
FS65001-0404-01	1/4	1/4-18 NPSM	7/16-20 UNF-2A	2.58	1.46	1.45	2.14	24 mm	15/16
FS65001-0606-01	3/8	3/8-18 NPSM	9/16-18 UNF-2A	2.51	1.46	1.45	2.14	24 mm	15/16
FS65001-0608-01	3/8	3/8-18 NPSM	3/4-16 UNF-2A	2.61	1.56	1.45	2.14	24 mm	15/16
FS65001-0808-01	1/2	1/2-14 NPSM	3/4-16 UNF-2A	2.77	1.52	1.62	2.39	29 mm	1
FS65001-0810-01	1/2	1/2-14 NPSM	7/8-14 UNF-2A	2.88	1.62	1.62	2.39	29 mm	1
FS65001-1212-01	3/4	3/4-14 NPSM	1 1/16-12 UN-2A	3.31	1.99	2.14	3.09	34 mm	1-1/4
FS65001-1616-01	1	1-11 1/2 NPSM	1 5/16-12 UN-2A	3.86	2.23	2.40	3.48	43 mm	1-5/8

Female Pipe Swivel (NPSM) x Male SAE O-Ring Boss

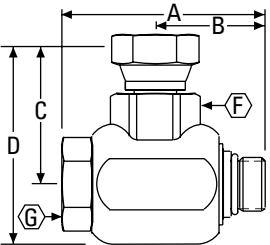

Part Number	Swivel Size	Casing Thread	Sleeve Thread	A	B	C	D	F	G
FS65002-0404-01	1/4	1/4-18 NPSM	7/16-20 UNF-2A	2.39	1.27	1.45	2.14	24 mm	15/16
FS65002-0405-01	1/4	1/4-18 NPSM	1/2-20UNF-2A	2.39	1.27	1.45	2.14	24 mm	15/16
FS65002-0606-01	3/8	3/8-18 NPSM	9/16-18UNF-2A	2.35	1.30	1.45	2.14	24 mm	15/16
FS65002-0608-01	3/8	3/8-18 NPSM	3/4-16UNF-2A	2.65	1.74	1.45	2.14	24 mm	15/16
FS65002-0808-01	1/2	1/2-14 NPSM	3/4-16UNF-2A	2.55	1.30	1.62	2.39	29 mm	1
FS65002-0810-01	1/2	1/2-14 NPSM	7/8-14UNF-2A	2.55	1.36	1.62	2.39	29 mm	1-1/16
FS65002-1212-01	3/4	3/4-14 NPSM	1 1/16-12 UN-2A	3.28	2.16	2.14	3.09	34 mm	1-1/4
FS65002-1616-01	1	1-11 1/2 NPSM	1 5/16-12 UN-2A	3.67	2.35	2.40	3.48	43 mm	1-5/8

Female Pipe Swivel (NPSM) x Female Pipes

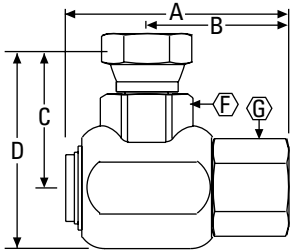

Part Number	Swivel Size	Casing Thread	Sleeve Thread	A	B	C	D	F	G
FS65005-0404-01	1/4	1/4-18 NPSM	1/4-18 NPTF	2.49	1.59	1.45	2.14	24 mm	15/16
FS65005-0606-01	3/8	3/8-18 NPTF	3/8-18 NPTF	2.49	1.58	1.45	2.14	24 mm	15/16
FS65005-0808-01	1/2	1/2-14 NPTF	1/2-14 NPTF	3.14	1.97	1.62	2.39	29 mm	1-1/16
FS65005-1212-01	3/4	3/4-14 NPTF	3/4-14 NPTF	3.21	2.08	2.14	3.09	34 mm	1-5/16
FS65005-1616-01	1	1-11 1/2 NPTF	1-11 1/2 NPTF	3.84	2.53	2.40	3.48	43 mm	1-5/8

Female Pipe x Male Pipe

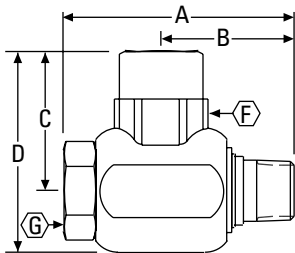

Part Number	Swivel Size	Casing Thread	Sleeve Thread	A	B	C	D	F	G
FS65007-0404-01	1/4	1/4-18 NPTF	1/4-18 NPTF	2.60	1.49	1.58	2.27	24 mm	15/16
FS65007-0606-01	3/8	3/8-18 NPTF	3/8-18 NPTF	2.53	1.48	1.59	2.28	24 mm	15/16
FS65007-0808-01	1/2	1/2-14 NPTF	1/2-14 NPTF	2.88	1.54	1.88	2.65	29 mm	1
FS65007-1212-01	3/4	3/4-14 NPTF	3/4-14 NPTF	3.21	1.89	2.30	3.25	34 mm	1-1/4
FS65007-1616-01	1	1-11 1/2 NPTF	1-11 1/2 NPTF	3.91	2.27	2.62	3.70	43 mm	1-5/8

Female Pipe x Female Pipe

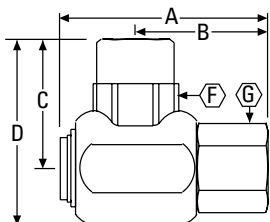

Part Number	Swivel Size	Casing Thread	Sleeve Thread	A	B	C	D	F	G
FS65008-0404-01	1/4	1/4-18 NPTF	1/4-18 NPTF	2.49	1.59	1.58	2.27	24 mm	15/16
FS65008-0606-01	3/8	3/8-18 NPTF	3/8-18 NPTF	2.49	1.58	1.59	2.28	24 mm	15/16
FS65008-0808-01	1/2	1/2-14 NPTF	1/2-14 NPTF	3.14	1.97	1.88	2.65	29 mm	1-1/16
FS65008-1212-01	3/4	3/4-14 NPTF	3/4-14 NPTF	3.21	2.08	2.30	3.25	34 mm	1-5/16
FS65008-1616-01	1	1-11 1/2 NPTF	1-11 1/2 NPTF	3.84	2.53	2.62	3.70	43 mm	1-5/8

Swivel Joints FS6500

Female Pipe x Male SAE 37°

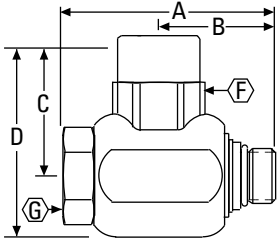

Part Number	Swivel Size	Casing Thread	Sleeve Thread	A	B	C	D	F	G
FS65010-0404-01	1/4	1/4-18 NPTF	7/16-20 UNF-2A	2.58	1.46	1.58	2.27	24 mm	15/16
FS65010-0808-01	1/2	1/2-14 NPTF	3/4-16 UNF-2A	2.77	1.52	1.88	2.65	29 mm	1
FS65010-1212-01	3/4	3/4-14 NPTF	1 1/16-12 UN-2A	3.31	1.99	2.30	3.25	34 mm	1-1/4
FS65010-1616-01	1	1-11 1/2 NPTF	1 5/16-12 UN-2A	3.86	2.23	2.62	3.70	43 mm	1-5/8

Female Pipe x Male SAE
O-Ring Boss

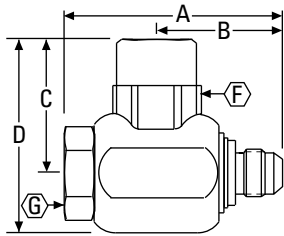

Part Number	Swivel Size	Casing Thread	Sleeve Thread	A	B	C	D	F	G
FS65011-0404-01	1/4	1/4-18 NPTF	7/16-20 UNF-2A	2.39	1.27	1.58	2.27	24 mm	15/16
FS65011-0606-01	3/8	3/8-18 NPTF	9/16-18 UNF-2A	2.35	1.30	1.59	2.28	24 mm	15/16
FS65011-0808-01	1/2	1/2-14 NPTF	3/4-16 UNF-2A	2.55	1.30	1.88	2.65	29 mm	1
FS65011-0810-01	1/2	1/2-14 NPTF	7/8-14 UNF-2A	2.88	1.36	1.88	2.65	29 mm	1-1/16
FS65011-1212-01	3/4	3/4-14 NPTF	1 1/16-12 UN-2A	3.28	2.16	2.30	3.25	34 mm	1-1/4
FS65011-1616-01	1	1-11 1/2 NPTF	1 5/16-12 UN-2A	3.67	2.35	2.62	3.70	43 mm	1-5/8

Male SAE 37° x Male Pipe

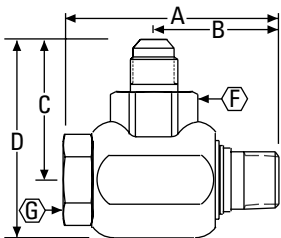

Part Number	Swivel Size	Casing Thread	Sleeve Thread	A	B	C	D	F	G
FS65003-0404-01	1/4	7/16-20 UNF-2A	1/4-18 NPTF	2.60	1.49	1.66	2.35	24 mm	15/16
FS65003-0504-01	1/4	1/2-20 UNF-2A	1/4-18 NPTF	2.60	1.49	1.66	2.35	24 mm	15/16
FS65003-0606-01	3/8	9/16-18 UNF-2A	9/16-18 NPTF	2.53	1.48	1.67	2.36	24 mm	15/16
FS65003-0806-01	3/8	3/4-16 UNF-2A	3/4-16 NPTF	2.53	1.58	1.77	2.46	24 mm	15/16
FS65003-0808-01	1/2	3/4-16 UNF-2A	1/2-14 NPTF	2.88	1.54	1.89	2.66	29 mm	1
FS65003-1008-01	1/2	7/8-14 UNF-2A	1/2-14 NPTF	2.88	1.54	2.00	2.77	29 mm	1
FS65003-1212-01	3/4	1 1/16-12 UN-2A	3/4-14 NPTF	3.21	1.89	2.36	3.31	34 mm	1-1/4
FS65003-1616-01	1	1 5/16-12 UN-2A	1-11 1/2 NPTF	3.91	2.27	2.60	3.68	43 mm	1-5/8

Male SAE 37°x Male SAE 37°

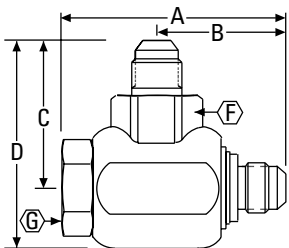

Part Number	Swivel Size	Casing Thread	Sleeve Thread	A	B	C	D	F	G
FS65004-0404-01	1/4	7/16-20 UNF-2A	7/16-20 UNF-2A	2.56	1.46	1.66	2.35	24 mm	15/16
FS65004-0505-01	1/4	1/2-20 UNF-2A	1/2-20 UNF-2A	2.56	1.46	1.66	2.35	24 mm	15/16
FS65004-0606-01	3/8	9/16-18 UNF-2A	9/16-18 UNF-2A	2.51	1.46	1.67	2.36	24 mm	15/16
FS65004-0808-01	3/8	3/4-16 UNF-2A	3/4-16 UNF-2A	2.61	1.56	1.77	2.46	24 mm	15/16
FS65004-1010-01	5/8	7/8-14 UNF-2A	7/8-14 UNF-2A	2.87	1.62	2.00	2.77	29 mm	1
FS65004-1212-01	3/4	1 1/16-12 UN-2A	1 1/16-12 UN-2A	3.31	1.99	2.36	3.31	34 mm	1-1/4
FS65004-1616-01	1	1 5/16-12 UN-2A	1 5/16-12 UN-2A	3.86	2.23	2.60	3.68	43 mm	1-5/8

Male SAE 37°x Male SAE
O-Ring Boss

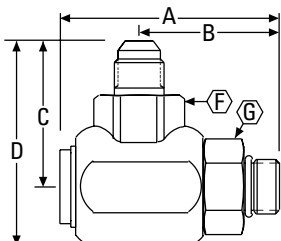

Part Number	Swivel Size	Casing Thread	Sleeve Thread	A	B	C	D	F	G
FS65009-0404-01	1/4	7/16-20 UNF-2A	7/16-20 UNF-2A	2.39	1.27	1.66	2.35	24 mm	15/16
FS65009-0505-01	1/4	1/2-20 UNF-2A	1/2-20 UNF-2A	2.39	1.27	1.66	2.35	24 mm	15/16
FS65009-0606-01	3/8	9/16-18 UNF-2A	9/16-18 UNF-2A	2.35	1.30	1.67	2.36	24 mm	15/16
FS65009-0808-01	3/8	3/4-16 UNF-2A	3/4-16 UNF-2A	2.65	1.74	1.77	2.46	24 mm	15/16
FS65009-1010-01	5/8	7/8-14 UNF-2A	7/8-14 UNF-2A	2.87	1.36	2.00	2.77	29 mm	1-1/16
FS65009-1212-01	3/4	1 1/16-12 UN-2A	1 1/16-12 UN-2A	3.28	2.16	2.36	3.31	34 mm	1-1/4
FS65009-1616-01	1	1 5/16-12 UN-2A	1 5/16-12 UN-2A	3.67	2.35	2.60	3.68	43 mm	1-5/8

Swivel Joints FS6500

Male SAE 37° x Female Pipe

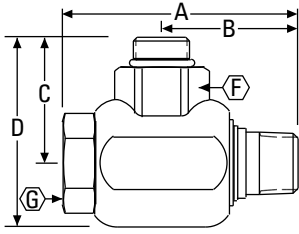

Part Number	Swivel Size	Casing Thread	Sleeve Thread	A	B	C	D	F	G
FS65016-1616-01	1	1 5/16-12 UN-2A	1-11 1/2 NPTF	3.84	2.53	2.60	3.68	43 mm	1-5/8

Male SAE O-Ring Boss x Male Pipe

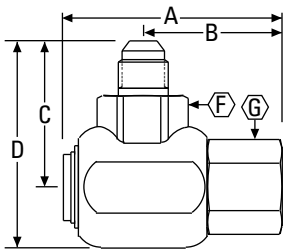

Part Number	Swivel Size	Casing Thread	Sleeve Thread	A	B	C	D	F	G
FS65013-1616-01	1	1 5/16-12 UN-2A	1-11 1/2 NPTF	3.91	2.27	2.37	3.45	43 mm	1-5/8

Male SAE O-Ring Boss x Female Pipe

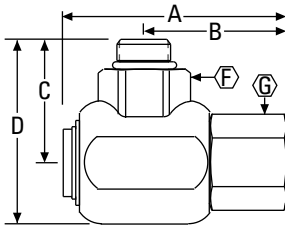

Part Number	Swivel Size	Casing Thread	Sleeve Thread	A	B	C	D	F	G
FS65017-1616-01	1	1 5/16-12 UN-2A	1-11 1/2 NPTF	3.84	2.53	2.37	3.45	43 mm	1-5/8

Male SAE O-Ring Boss x Male SAE 37°

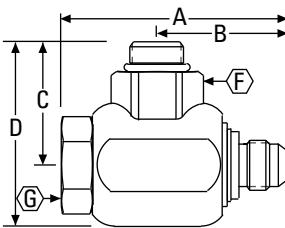

Part Number	Swivel Size	Casing Thread	Sleeve Thread	A	B	C	D	F	G
FS65020-1616-01	1	1 5/16-12 UN-2A	1 5/16-12 UN-2A	3.86	2.23	2.37	3.45	43 mm	1-5/8

Male SAE O-Ring Boss x Male SAE O-Ring Boss

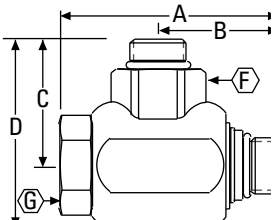

Part Number	Swivel Size	Casing Thread	Sleeve Thread	A	B	C	D	F	G
FS65023-1616-01	1	1 5/16-12 UN-2A	1 5/16-12 UN-2A	3.67	2.35	2.37	3.45	43 mm	1-5/8

Swivel Joints FS6500

Female SAE O-Ring Boss x Male Pipe

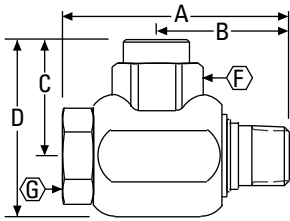

Part Number	Swivel Size	Casing Thread	Sleeve Thread	A	B	C	D	F	G
FS65014-1616-01	1	1 5/16-12 UN-2B	1-11 1/2 NPTF	3.91	2.27	2.32	3.40	43 mm	1-5/8

Female SAE O-Ring Boss x Female Pipe

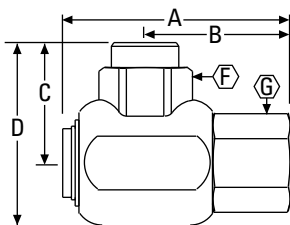

Part Number	Swivel Size	Casing Thread	Sleeve Thread	A	B	C	D	F	G
FS65018-1616-01	1	1 5/16-12 UN-2B	1-11 1/2 NPTF	3.84	2.53	2.32	3.40	43 mm	1-5/8

Female SAE O-Ring Boss x Male SAE 37°

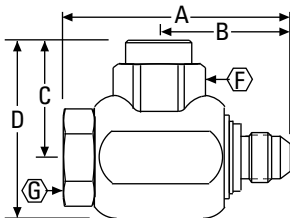

Part Number	Swivel Size	Casing Thread	Sleeve Thread	A	B	C	D	F	G
FS65021-1616-01	1	1 5/16-12 UN-2B	1 5/16-12 UN-2A	3.86	2.23	2.32	3.40	43 mm	1-5/8

Female SAE O-Ring Boss x Male SAE O-Ring Boss

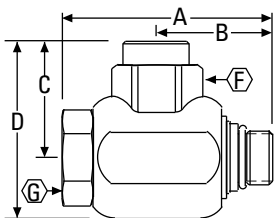

Part Number	Swivel Size	Casing Thread	Sleeve Thread	A	B	C	D	F	G
FS65024-1616-01	1	1 5/16-12 UN-2B	1 5/16-12 UN-2A	3.67	2.35	2.32	3.40	43 mm	1-5/8

Male ORS x Male O-Ring Boss

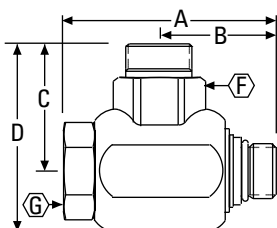

Part Number	Swivel Size	Casing Thread	Sleeve Thread	A	B	C	D	F	G
FS65025-1212-01	3/4	1 3/16-12 UN-2A	1 1/16-12 UN-2A	3.28	2.16	2.25	3.20	34 mm	1-1/4
FS65025-1616-01	1	1 7/16-12 UN-2A	1 5/16-12 UN-2A	3.67	2.35	2.55	3.63	43 mm	1-5/8

Swivel Joints

BD5500

The BD5500 Series industrial Swivel Joint's pressure balanced design distributes pressure evenly through the body of the joint which eliminates axial loading of the sleeve. This pressure balanced design allows the BD5500 Series Swivel Joint to turn with very low torque even under pressures up to 3000 psi.

Available sizes: -20 and -24 Operating Pressure: 3000 psi.

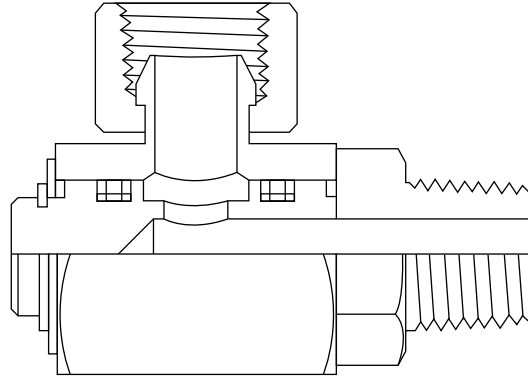

Torque vs Pressure

This chart shows the low torque required to rotate the BD5500 Series Swivel Joint while under pressure. This data is based on actual testing of production assemblies.

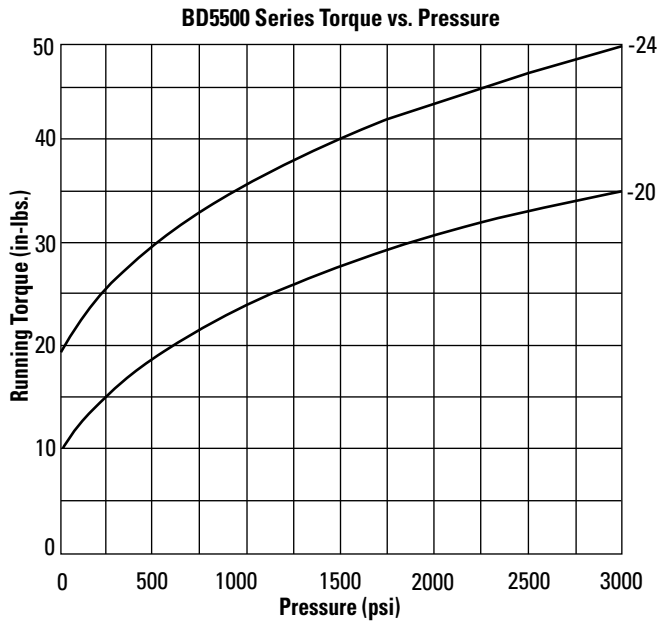

Pressure Drop vs Flow

These test results for pressure drop at various flow rates were made with MIL-H-5606A oil at temperatures (+70°F to +80°F) on production assemblies.

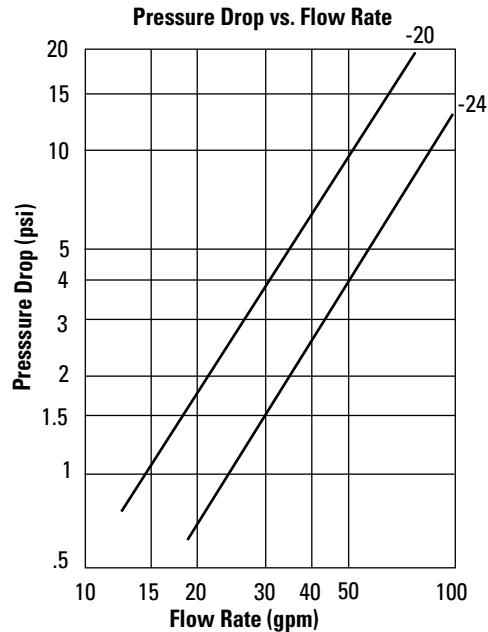

Seal Options:

Suffix Number	Material	Standard	Optional
-01	Buna-N	X	
-04	EPR		X
-06	Fluorocarbon		X

Pressure Rating for BD5500:

Size	Operating Pressure
All Sizes	25 in./Hg vacuum to 3000 psi

Swivel Joints BD5500

Female Pipe Swivel to Male Pipe

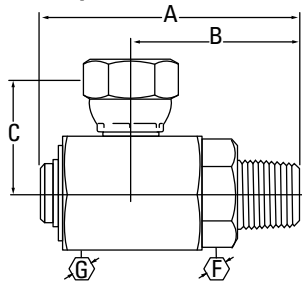

Part Number	Swivel Size	Casing Thread	Sleeve Thread	A	B	C	F	G
BD55000-2020-01	1-1/4"	1-1/4-11-1/2 NPSM	1-1/4-11 1/2 NPTF	4.88	3.16	2.00	1.75	2.50
BD55000-2424-01	1-1/2"	1-1/2-11-1/2 NPSM	1-1/2-11 1/2 NPTF	5.30	3.50	2.25	2.12	3.00

Female Pipe Swivel to Male SAE 37°

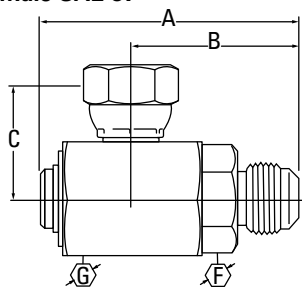

Part Number	Swivel Size	Casing Thread	Sleeve Thread	A	B	C	F	G
BD55001-2020-01	1-1/4"	1-1/4-11-1/2 NPSM	1-5/8-12 UN-2A	4.88	3.16	2.00	1.75	2.50
BD55001-2424-01	1-1/2"	1-1/2-11-1/2 NPSM	1-7/8-12 UN-2A	5.30	3.50	2.25	2.12	3.00

Female Pipe Swivel to Male SAE O-Ring

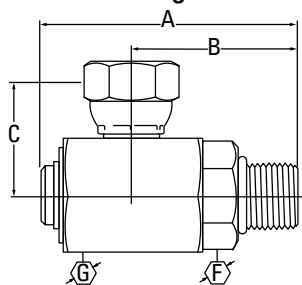

Part Number	Swivel Size	Casing Thread	Sleeve Thread	A	B	C	F	G
BD55004-2020-01	1-1/4"	1-1/4-11-1/2 NPSM	1-5/8-12 UN-2A	4.60	2.89	2.00	1.88	2.50
BD55004-2424-01	1-1/2"	1-1/2-11-1/2 NPSM	1-7/8-12 UN-2A	5.06	3.27	2.25	2.12	3.00

Male SAE 37° to Male Pipe

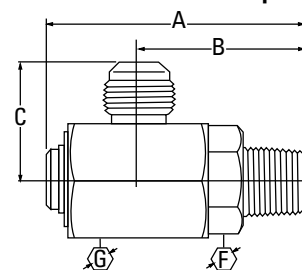

Part Number	Swivel Size	Casing Thread	Sleeve Thread	A	B	C	F	G
BD55005-2020-01	1-1/4"	1-5/8-12 UN-2A	1-1/4-11-1/2 NPTF	4.88	3.16	2.20	1.75	2.50
BD55005-2424-01	1-1/2"	1-7/8-12 UN-2A	1-1/2-11-1/2 NPTF	5.30	3.50	2.57	2.12	3.00

Male SAE 37° to Male SAE 37°

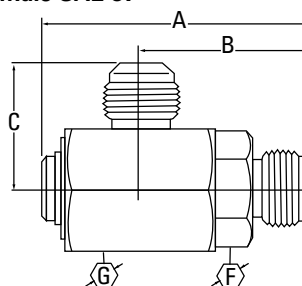

Part Number	Swivel Size	Casing Thread	Sleeve Thread	A	B	C	F	G
BD55009-2020-01	1-1/4"	1-5/8-12 UN-2A	1-5/8-12 UN-2A	4.88	3.16	2.20	1.75	2.50
BD55009-2424-01	1-1/2"	1-7/8-12 UN-2A	1-7/8-12 UN-2A	5.30	3.50	2.57	2.12	3.00

Swivel Joints BD5500

Female Pipe Swivel to Female Pipe

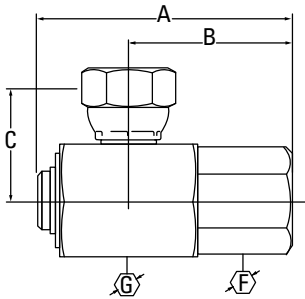

Part Number	Swivel Size	Casing Thread	Sleeve Thread	A	B	C	F	G
BD55011-2020-01	1-1/4"	1 1/4-11 1/2 NPSM	1 1/4-11-1/2 NPTF	4.50	2.78	2.00	2.00	2.50
BD55011-2424-01	1-1/2"	1 1/2-11 1/2 NPSM	1 1/2-11-1/2 NPTF	4.62	2.82	2.25	2.38	3.00

Male Pipe to Male Pipe

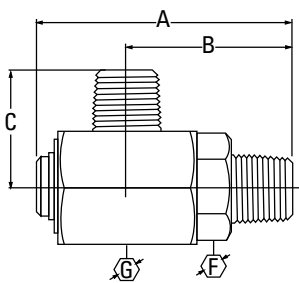

Part Number	Swivel Size	Casing Thread	Sleeve Thread	A	B	C	F	G
BD55012-2020-01	1-1/4"	1-1/4-11-1/2 NPTF	1-1/4-11-1/2 NPTF	4.88	3.16	2.27	1.75	2.50
BD55012-2424-01	1-1/2"	1-1/2-11-1/2 NPTF	1-1/2-11-1/2 NPTF	5.30	3.50	2.54	2.12	3.00

Female Pipe Fixed to Male Pipe

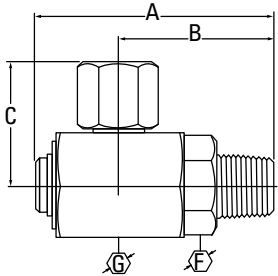

Part Number	Swivel Size	Casing Thread	Sleeve Thread	A	B	C	F	G
BD55014-2020-01	1-1/4"	1-1/4-11-1/2 NPTF	1-1/4-11-1/2 NPTF	4.88	3.16	2.77	1.75	2.50
BD55014-2424-01	1-1/2"	1-1/2-11-1/2 NPTF	1-1/2-11-1/2 NPTF	5.30	3.50	3.02	2.12	3.00

Female Pipe Fixed to Female Pipe

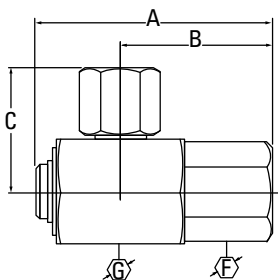

Part Number	Swivel Size	Casing Thread	Sleeve Thread	A	B	C	F	G
BD55015-2020-01	1-1/4"	1-1/4-11-1/2 NPTF	1-1/4-11-1/2 NPTF	4.50	2.78	2.77	2.00	2.50
BD55015-2424-01	1-1/2"	1-1/2-11-1/2 NPTF	1-1/2-11-1/2 NPTF	4.62	2.82	3.02	2.38	3.00

Male SAE 37° to Male SAE O-Ring

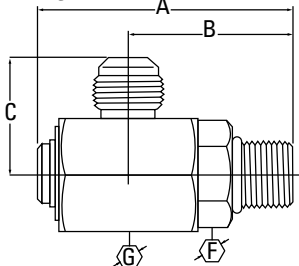

Part Number	Swivel Size	Casing Thread	Sleeve Thread	A	B	C	F	G
BD55021-2020-01	1-1/4"	1-5/8-12 UN-2A	1-5/8-12 UN-2A	4.60	2.89	2.20	1.88	2.50
BD55021-2424-01	1-1/2"	1-7/8-12 UN-2A	1-7/8-12 UN-2A	5.06	3.27	2.57	2.12	3.00

Swivel Joints BD5500

Female Pipe Fixed to Male SAE 37°

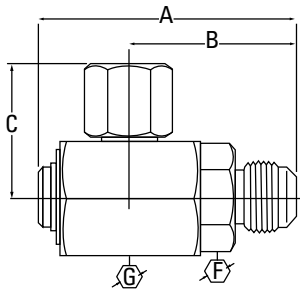

Part Number	Nom. Size	Casing Thread	Sleeve Thread	A	B	C	F	G
BD55029-2020-01	1 1/4"	1 1/4-11-1/2 NPTF	15/8-12 UN-2A	4.88	3.16	2.77	1.75	2.50

Female Pipe Fixed to Male SAE O-Ring

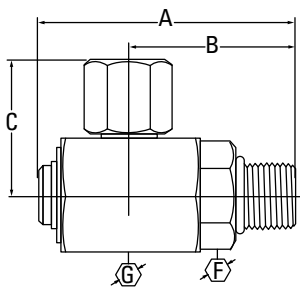

Part Number	Nom. Size	Casing Thread	Sleeve Thread	A	B	C	F	G
BD55031-2020-01	1 1/4"	1 1/4-11-1/2 NPTF	15/8-12 UN-2A	4.60	2.89	2.77	1.88	2.50

BD5500 Repair Kits

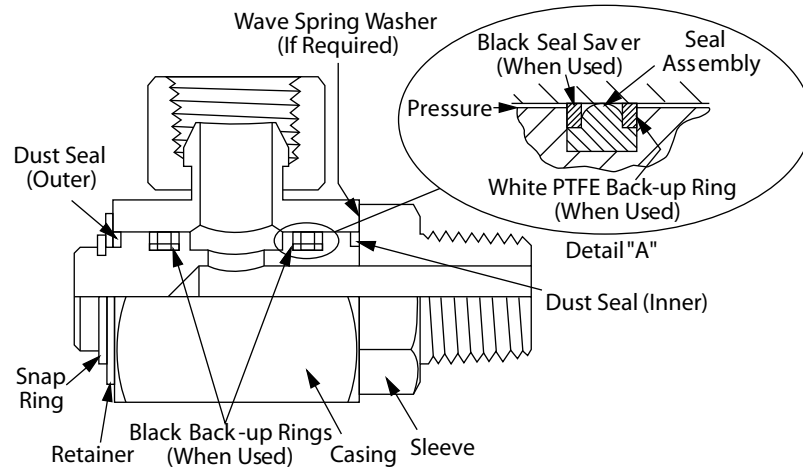

Replacement seal kit consists of (2) TRI-RING SEAL™ assemblies, (2) dust seals, (1) washer and (1) snap ring.

Seal Type Nominal Size		Seal Kit Part Numbers						
		1/4"	3/8"	1/2"	3/4"	1"	1 1/4"	1 1/2"
Buna-N	(Code -01)	10-62017-01	10-62018-01	10-62019-01	10-62020-01	10-62021-01	10-62022-01	10-62023-01
EPR	(Code -04)	10-62017-04	10-62018-04	10-62019-04	10-62020-04		10-62022-04	10-62023-04
Fluorocarbon	(Code -06)	10-62017-06	10-62018-06	10-62019-06	10-62020-06	10-62021-06	10-62022-06	10-62023-06

Swivel Joints FS5900

The FS5900 Series Swivel Joint is designed for 25 in./Hg vacuum to 5000 psi operating pressure service made possible by advanced design needle bearings and seals. In addition to high pressures, the FS5900 series provides full fluid flow with minimal pressure drop.

The excellent corrosion resistance of the FS5900 series is made possible by the plated steel components.

Both field and laboratory testing have proven the FS5900 Series Swivel Joints can withstand greater side loads than conventional swivel joints. High pressure impulse life has also been improved.

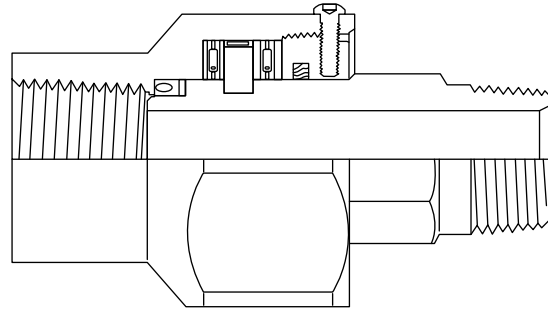

Torque vs Pressure

Testing to determine the torque required to rotate an FS5900 Series Swivel Joint was conducted on actual production assemblies.

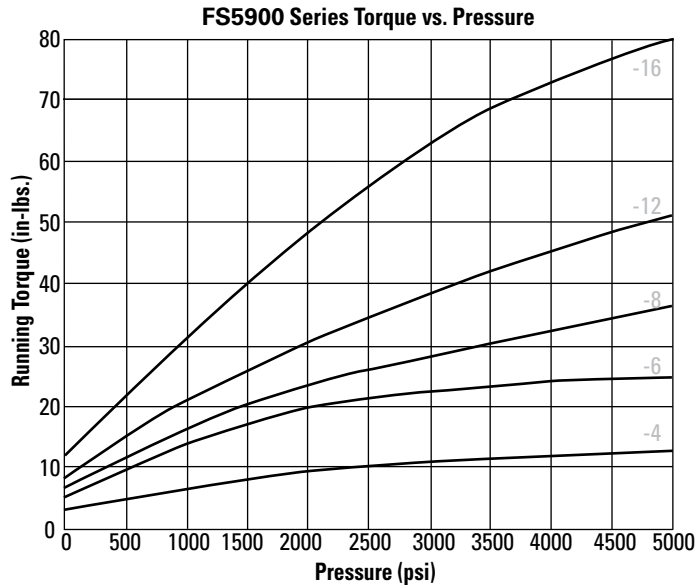

Pressure Drop vs Flow

Testing for pressure drop at various flow rates was conducted with MIL-H-5606 hydraulic oil at temperatures (+70°F to +80°F).

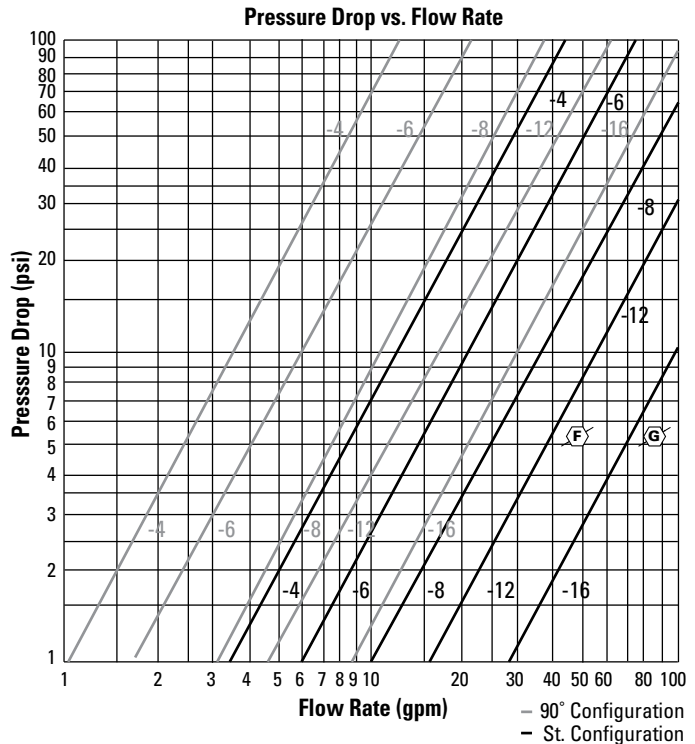

Seal Options:

O-Ring Seals (1/4 inch size only)

Suffix Number	Material	Temp Range	Standard	Optional
-01	Buna-N	-40°F to 250°F	X	
-04	EPR	-60°F to 300°F		X
-06	Flourocarbon	-20°F to 300°F		X

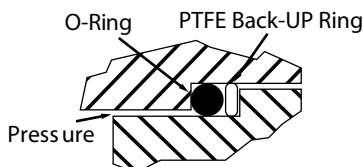

U-Cup Seals (3/8" through 1" sizes)

Suffix Number	Material	Temp Range	Standard	Optional
-75	Hytrel/Buna	-20°F to 250°F	X	
-74	Urethane/Buna	-40°F to 180°F		X

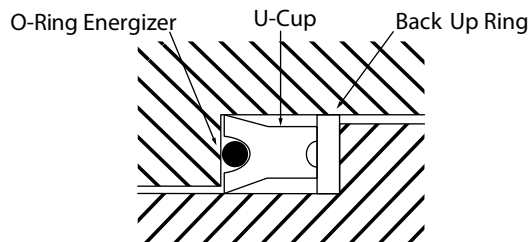

Swivel Joints FS5900

(Straight) Female Pipe to Female Pipe

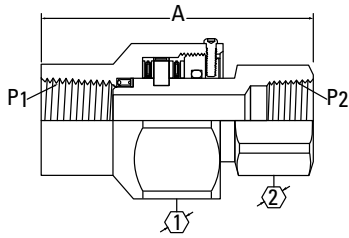

Part Number	Nom. Size	Thread P1	Thread P2	A	B	①	②
FS59001-1616-75	1"	1-11-1/2 NPTF	1-11-1/2 NPTF	4.31		2.50	1.62

Female Pipe to Male Pipe

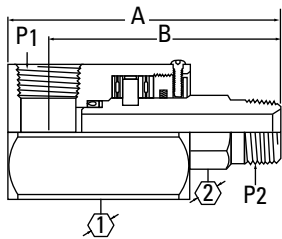

Part Number	Nom. Size	Thread P1	Thread P2	A	B	①	②
FS59002-0404-01	1/4"	1/4-18 NPTF	1/4-18 NPTF	3.20	2.82	1.19	.56
FS59002-0606-75	3/8"	3/8-18 NPTF	3/8-18 NPTF	3.67	3.21	1.88	.94
FS59002-0808-75	1/2"	1/2-14 NPTF	1/2-14 NPTF	4.01	3.45	1.88	.94
FS59002-1212-75	3/4"	3/4-14 NPTF	3/4-14 NPTF	4.32	3.64	2.12	1.19
FS59002-1616-75	1"	1-11-1/2 NPTF	1-11-1/2 NPTF	4.88	4.08	2.50	1.44

Female Pipe to Male SAE 37°

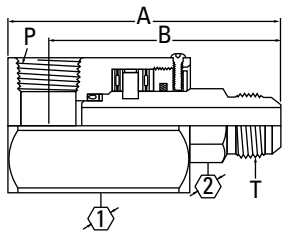

Part Number	Nom. Size	Thread P1	Thread P2	A	B	①	②
FS59003-0405-01	1/4"	1/4-18 NPTF	1/2-20 UNF-2A	3.19	2.81	1.19	.56
FS59003-0608-75	3/8"	3/8-18 NPTF	3/4-16 UNF-2A	3.77	3.31	1.88	.94
FS59003-0810-75	1/2"	1/2-14 NPTF	7/8-14 UNF-2A	4.00	3.44	1.88	.94
FS59003-1212-75	3/4"	3/4-14 NPTF	1 1/16-12 UN-2A	4.43	3.75	2.12	1.19
FS59003-1616-75	1"	1-11-1/2 NPTF	15/16-12 UN-2A	4.85	4.05	2.50	1.44

Female Pipe to Male Pipe

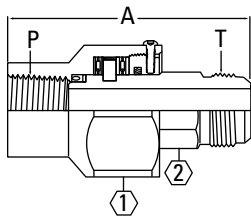

Part Number	Nom. Size	Thread P1	Thread P2	A	B	①	②
FS59004-0404-01	1/4"	1/4-18 NPTF	1/4-18 NPTF	3.23		1.19	.56
FS59004-0606-75	3/8"	3/8-18 NPTF	3/8-18 NPTF	3.62		1.88	.94
FS59004-0808-75	1/2"	1/2-14 NPTF	1/2-14 NPTF	3.97		1.88	.94
FS59004-1212-75	3/4"	3/4-14 NPTF	3/4-14 NPTF	4.04		2.12	1.19
FS59004-1616-75	1"	1-11-1/2 NPTF	1-11-1/2 NPTF	4.57		2.50	1.44

Swivel Joints FS5900

Female Pipe to Male SAE 37°

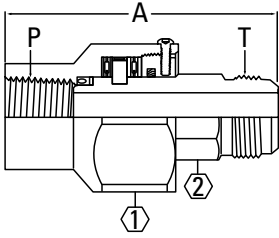

Part Number	Nom. Size	Thread P1	Thread P2	A	B	①	②
FS59005-0405-01	1/4"	1/4-18 NPTF	1/2-20 UNF-2A	3.22		1.19	.56
FS59005-0608-75	3/8"	3/8-18 NPTF	3/4-16 UNF-2A	3.72		1.88	.94
FS59005-0810-75	1/2"	1/2-14 NPTF	7/8-14 UNF-2A	3.96		1.88	.94
FS59005-1212-75	3/4"	3/4-14 NPTF	1-1/16-12 UN-2A	4.15		2.12	1.19
FS59005-1616-75	1"	1-11-1/2 NPTF	1-5/16-12 UN-2A	4.54		2.50	1.44

Male SAE 37° to Female SAE 37°

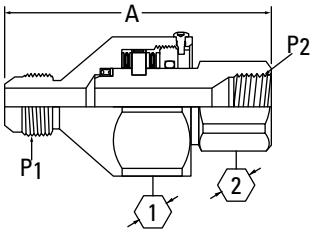

Part Number	Nom. Size	Thread P1	Thread P2	A	B	①	②
FS59006-0505-01	1/4"	1/2-20 UNF-2A	1/2-20 UNF-2B	2.98		1.19	.62
FS59006-0808-75	3/8"	3/4-16 UNF-2A	3/4-16 UNF-2B	3.48		1.88	.94
FS59006-1010-75	1/2"	7/8-14 UNF-2A	7/8-14 UNF-2B	3.74		1.88	1.00
FS59006-1212-75	3/4"	1-1/16-12 UN-2A	1-1/16-12 UN-2B	3.88		2.12	1.25
FS59006-1616-75	1"	1-5/16-12 UN-2A	1-5/16-12 UN-2B	4.03		2.50	1.50

Male SAE 37° to Female SAE 37°

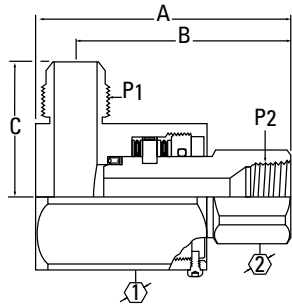

Part Number	Nom. Size	Thread P1	Thread P2	A	B	C	①	②
FS59011-0505-01	1/4"	1/2-20 UNF-2A	1/2-20 UNF-2B	2.69	2.41	1.16	1.19	.62
FS59011-0808-75	3/8"	3/4-16 UNF-2A	3/4-16 UNF-2B	3.08	2.73	1.59	1.88	.94
FS59011-1010-75	1/2"	7/8-14 UNF-2A	7/8-14 UNF-2B	3.46	3.06	1.70	1.88	1.00
FS59011-1212-75	3/4"	1-1/16-12 UN-2A	1-1/16-12 UN-2B	3.58	3.08	1.93	2.12	1.25
FS59011-1616-75	1"	1-5/16-12 UN-2A	1-5/16-12 UN-2B	3.91	3.29	2.16	2.50	1.50

FS5900 Repair Kits

The FS5900 Series Swivel Joints are easily field repaired. Two different kits are available. The choice of which kit to use is dependent upon the extent of repairs necessary.

FF974 Kits include: a replacement seal assembly, back-up rings and a new dust seal.

FF975 Kits include: a replacement seal assembly, back-up rings, a new dust seal and two sets of bearings and races.

To order FF974 and FF975 Kits: FF974- 08- 75

Kit Base Number _____

Joint Size _____
(Swivel Joint Nominal size 1/2")

Seal Material Code _____

(see Seal Options chart on page 16)

NOTE: Use swivel joint nominal size when ordering kits, not port size.

Eaton
Hydraulics Group USA
14615 Lone Oak Road
Eden Prairie, MN 55344
USA
Tel: 952-937-9800
Fax: 952-294-7722
www.eaton.com/hydraulics

Eaton
Hydraulics Group Europe
Route de la Longeraie 7
1110 Morges
Switzerland
Tel: +41 (0) 21 811 4600
Fax: +41 (0) 21 811 4601

Eaton
Hydraulics Group Asia Pacific
Eaton Building
4th Floor, No. 3 Lane 280 Linhong Rd.
Changning District
Shanghai 200335
China
Tel: (+86 21) 5200 0099
Fax: (+86 21) 5200 0400