



Flexmaster Joints

Conveying Products



Features

Flexmaster Joints in Standard and Self-restrained Configurations

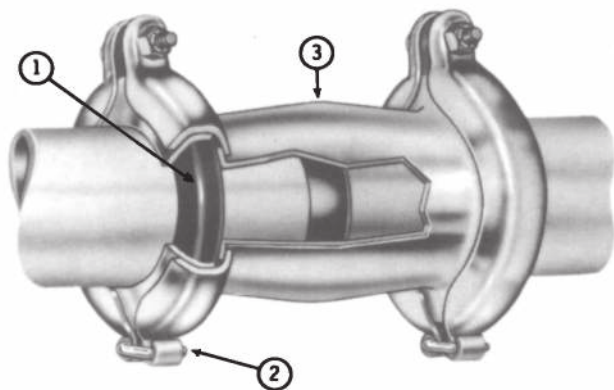

Standard Features

1. Gasket provides compression seal when tightened against tube or pipe.
2. Hinged coupling provides for quick, easy assembly.
3. Bulged sleeve allows for $\pm 4^\circ$ angular misalignment.

All gasket materials listed on page 4 are available in the standard style, increasing the number of suitable applications.

Flexmaster joints are available in both standard and self-restrained styles. The self-restrained style has a stainless steel gripping ring inside each gasket. This feature allows the joint to maintain a firm grip on the pipe or tube, preventing movement along the pipe or tube.

The bulged, straight-through Flexmaster joints accommodate angular misalignment up to $\pm 4^\circ$ per end. Tees, elbows, and crosses accommodate angular misalignment up to $\pm 2^\circ$ per end. See pages 10 thru 17 for the angular misalignment allowed on each specific part. Flexmaster joints are designed for up to 300 psi (2.07 MPa) service, depending on application and size. Refer to pressure ratings on page 4.

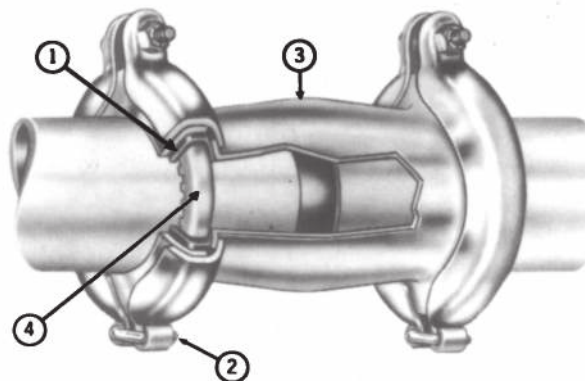

Self-Restrained Features

1. Gasket provides compression seal when tightened against tube or pipe.
2. Hinged coupling provides for quick, easy assembly.
3. Bulged sleeve allows for $\pm 4^\circ$ angular misalignment.
4. Notched channel ring which grips pipe firmly to restrict movement along pipe or tubing.

Gasket materials available include the C (Buna-N) and D (EPDM) compounds.

Flexmaster joints absorb vibration and are ideal for making quick connections and disconnections when repairing or disassembling a system. They can be furnished with several types of gasket compounds and sleeve materials, including stainless steel for marine and corrosive applications.

Flexmaster joints are currently in use in thousands of applications throughout the world. For typical Flexmaster joint applications see photos on page 2.

Features

Save Time -
Make Pipe And
Tube Connection
Easier

Used on Plain End Tube or Pipe

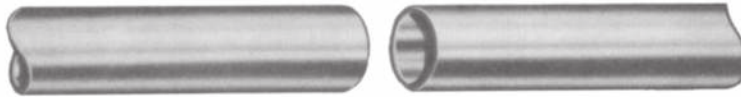

No threading, flanging, welding, grooving or other special end preparation of tube or pipe is required. Use pipe after it is cut to appropriate lengths. The Flexmaster joint will accommodate large tolerances in the length of the gap. See Table 1, page 9 for insertion depth tolerances.

Absorbs Vibration

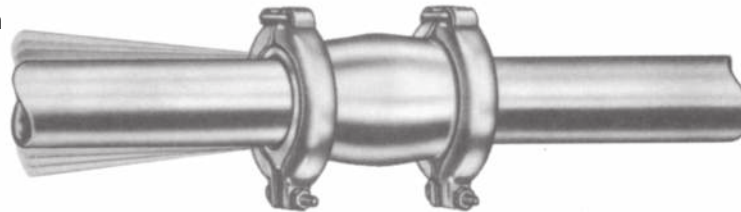

Pipe vibration and noise can be drastically reduced with Flexmaster joints. The resilient, thick rubber of the Flexmaster joint gasket absorbs vibration and noise. Use of the self-restrained style restricts movement along vibrating pipes and tubes.

Even Misaligned Piping is No Problem

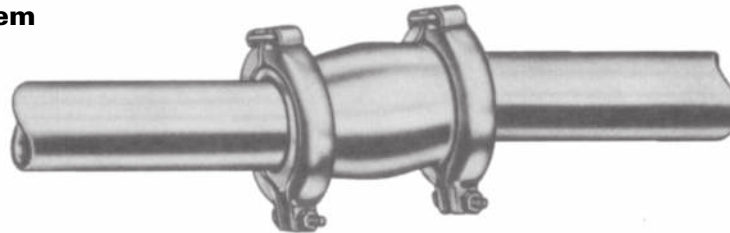

The Flexmaster joint design eliminates flanged bolt holes and pipe threads that require careful alignment. The Flexmaster bulged joint permits up to a total of $\pm 4^\circ$ angular installation misalignment at each end while maintaining a leakproof seal.

Easy to Install

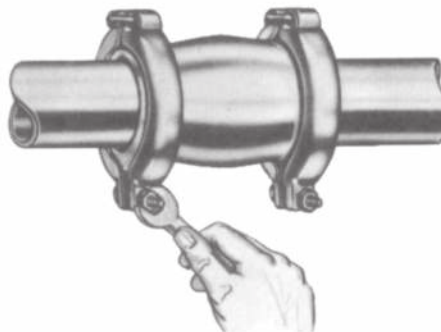

Installation time can be slashed by using Flexmaster joints. Basic assembly tools are all that's needed. After extensive use, the gaskets can be replaced easily and quickly. See page 8 for complete assembly instructions.

Applications

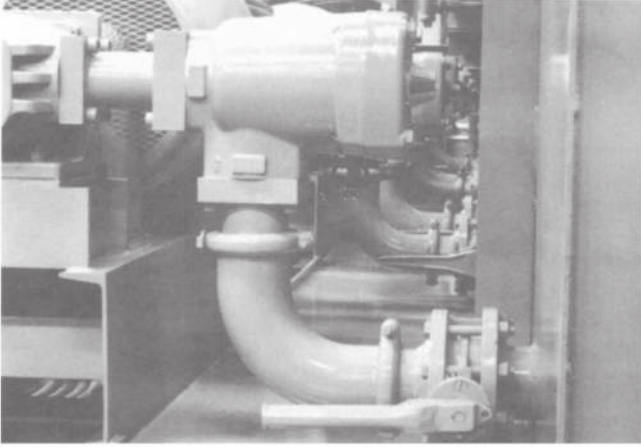

Flexmaster joint elbows on a large hydraulic power system, which connect pipe from pumps to hydraulic fluid reservoirs.

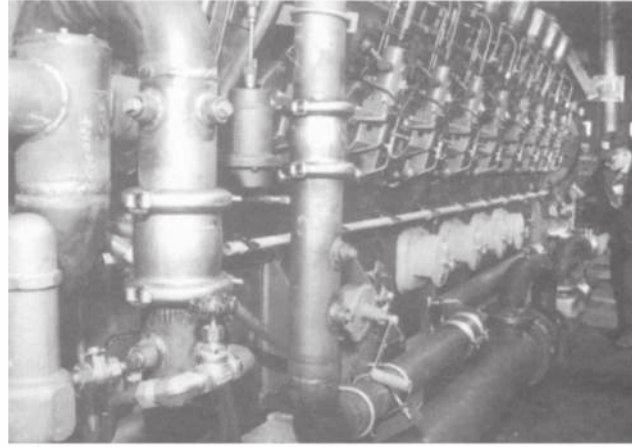

Flexmaster joints join water lines on a huge diesel engine.

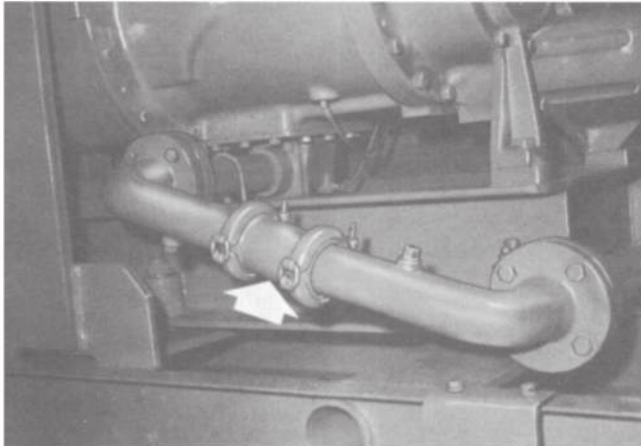

A number of Flexmaster joints are installed on this compressor to connect water and oil lines, providing quick, easy connection and protection against vibration.

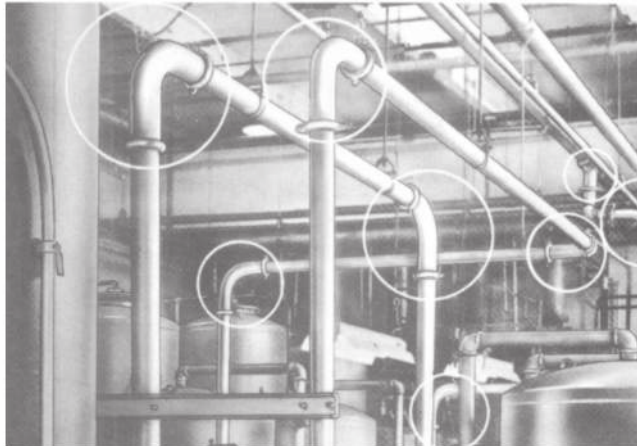

A large dry-cleaning plant uses Flexmaster joints to connect piping at elbow junctures.

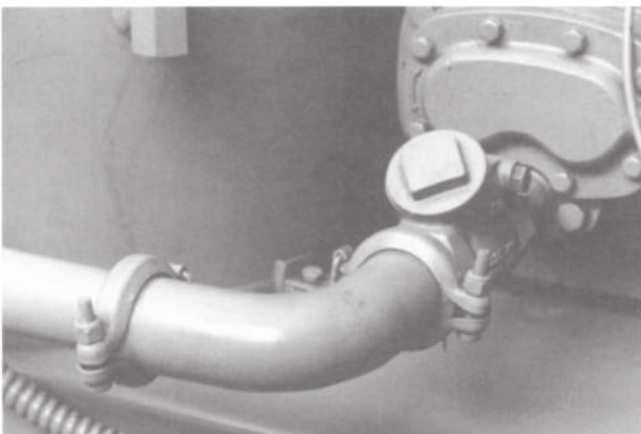

Flexmaster joints are used to join piping on air compressors.

Specials

Made to Order

Special Configurations and Seal Materials Can Be Ordered

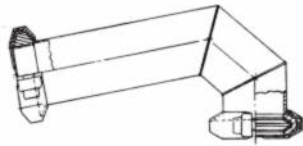

**Salt Water,
All 316 Stainless**

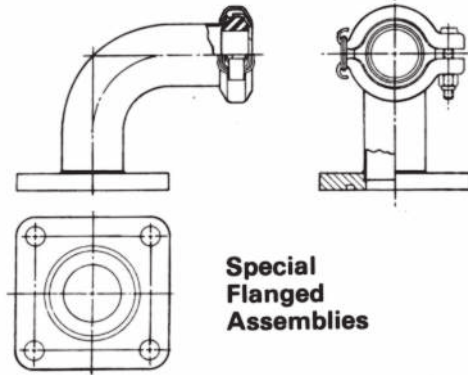

**Special
Flanged
Assemblies**

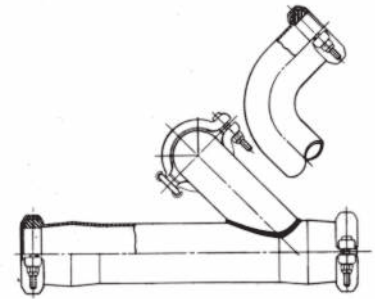

Lube Oil, Special Configuration

Flexmaster joints can be produced with various configurations and terminal end designs. A few of the special Flexmaster joint configurations which have been manufactured by Eaton are displayed above. Please consult Eaton when ordering specials.

Manufacturing



Flexmaster joints are manufactured by highly experienced and trained individuals who are dedicated solely to the production and packaging of Flexmaster joints.

Engineering

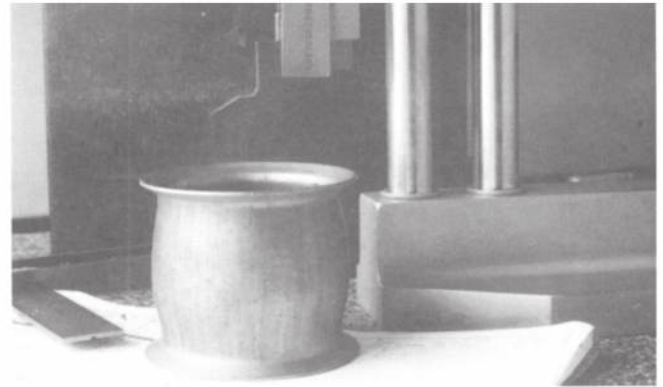
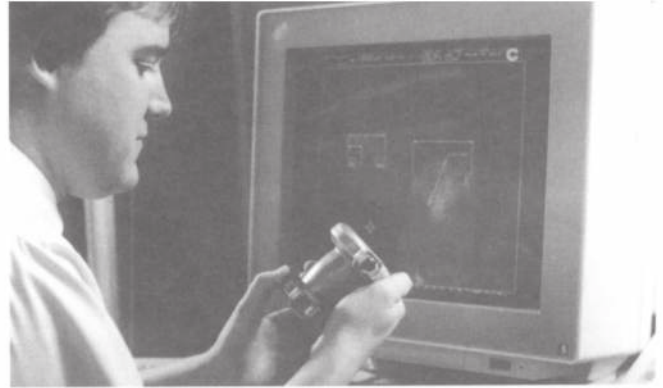

The Flexmaster joints manufacturing team is backed by the strong technical support from Eaton's engineering staff.

Technical Data

GASKET TEMPERATURE RATINGS††

C BUNA-N (Standard)	water	-25° F. to +180° F. (-32° C. to +82° C.)
	oils	-25° F. to +212° F. (-32° C. to +100° C.)
V Fluorocarbon		-25° F. to +450° F. (-32° C. to +232° C.)
S Silicone		-65° F. to +350° F. (-54° C. to +177° C.)
D EPDM	water and water/glycol mixture	+20° F. to +275° F. (+29° C. to +137° C.)
N BUNA-N (High temp.)	water and steam	-25° F. to +225° F. (-32° C. to +107° C.)
	oils	-25° F. to +250° F. (-32° C. to +121° C.)

†† Maximum temperature ratings are meant as a guide only.
For extreme temperature conditions, consult factory.

PRESSURE RATINGS †

Size Range Pipe	Tube	Standard Gasket	Self-Restrained Gasket
3/8 - 3/4	1/2 - 1 3/8	300 psi (2.07 MPa)	300 psi (2.07 MPa)
	12.7 - 35.1		
1-2	1 1/2 - 2 1/2	200 psi (1.38 MPa)	200 psi (1.38 MPa)
	38.1 - 63.5		
2 1/2 - 6	3 - 6	150 psi (1.03 MPa)	150 psi (1.03 MPa)
	76.2 - 152.4		

† **Warning:** The Flexmaster joint is designed to seal pipe and tube connections. The Flexmaster joint is not intended to hold piping systems together. Normal hangers, guides, anchors and other external piping restraints must be used to restrain the piping or tubing system from movement.

PIPE AND TUBE MATERIALS WHICH CAN BE CONNECTED BY FLEXMASTER JOINTS*

Pipe or Tube Material	Standard Gasket	Self-Restrained Gasket**
Carbon Steel	X	X
Stainless Steel	X	X
Aluminum	X	Not Recommended
P.V.C. (Plastic)	X	Not Recommended
Copper	X	Not Recommended

* All piping and tubing connected by Flexmaster joints must meet the nominal O.D. dimensions presented on pages 10 - 17.

** Piping and Tubing, which use self-restrained gaskets, must have a hardness between 45-85 on a Rockwell "B" scale (45 - 85 Rb).

VACUUM RATINGS †

Size Range Pipe	Tube	Standard Gasket	Self-Restrained Gasket
All sizes	All sizes	25 in. Hg. 1.79 bar	25 in. Hg. 1.79 bar

NOTE:

† F., inches, in. Hg., psi in bold

† C., mm, bar, MPa in light

EATON GASKET IDENTIFIER CHART

Gasket Designation	Gasket Compound	Gasket Color	Identifying Color Patch
C	Buna N (std)	Black	Yellow or White
N	Buna N (high temp)	Black	Rust Orange
D	EPDM	Black	Dark Blue
V	Fluorocarbon	Black	Light Green
S	Silicone	Rust Orange	None

Technical Data

Gasket Selector Chart

Gasket Material: C – BUNA-N (standard)
 D – EPDM
 N – BUNA-N
 (high temperature)
 V – Fluorocarbon
 S – Silicone

Key: G – GOOD
 F – FAIR
 - Not Recommended

An important consideration in the selection of a gasket material is to avoid undesirable chemical reaction between the agent carried and the gasket material. The gasket selector chart indicates the compound most serviceable in specific agents.

FLUID	GASKET MATERIAL			
	D	C/N	V	S
Acetic Acid (concentrated) RT	F	F	G	F
Acetic Acid (dilute) RT (to 10%)	F	F	G	G
Acetic Acid Vapors	F	F	F	F
Acedit Anhydride	-	F	-	F
Acetone	G	-	-	F
Acetylene	G	G	G	F
Air	G	G	G	G
Air (Hot) 215°	G	F	G	G
Alcohols, Aliphatic	G	F	G	G
Alcohols, Aromatic	F	-	F	F
Alkaline Solutions (Hydroxides)	F	G	F	G
Aluminum Salt solutions	G	G	G	G
Ammonia Gas (Cold)	G	G	-	-
Ammonia, Liquid (Anhydrous)	G	G	-	F
Ammonia Aqueous	G	F	-	G
Ammonium Salt Solutions	G	G	F	F
Aniline Dyes	F	-	G	F
Aniline Oils	F	-	F	F
Asphalt	-	-	G	-
Benzene (Gasoline)	-	G	G	-
Bromine	-	-	G	-
Butylene	-	F	G	-
Calcium Hypochlorite (no free Chlorine)	G	-	G	F
Calcium Salt solutions	G	G	G	F
Carbolic Acid (Phenol) RT or Hot	F	-	G	-
Carbon Dioxide (Dry)	G	G	F	F
Carbonic Acid	G	F	G	G
Carbon Disulphide RT	-	-	G	-
Carbon Tetrachloride RT	-	-	G	-
Chlorinated Solvents	-	-	G	G
Chlorine (Dry)	-	-	G	-
Chlorine (wet or solutions)	F	-	G	-
Cottonseed Oil	G	G	G	G
Creosote (wood or coal tar)	-	G	G	-
Chromic Acid 50%	-	F	G	-
Citric Acid	G	G	G	G
Copper Salt Solutions	G	F	G	G
Diesel Fuel	-	G	G	-
Ethers RT	F	F	G	-
Ethylene Glycol	G	G	G	G
Ethylene Dichloride	-	-	G	G
Ferric Salt Solutions	G	G	G	G
Ferrous Salt Solutions	G	G	G	G
Formaldehyde RT	F	-	-	G
Fuel Oil	-	G	F	-
Furfural	G	-	-	-
Freon 12 (Refrigerant)	G	G	G	-
Freon 13 (Refrigerant)	F	G	G	-
Gasoline (Sour or refined)	-	G	G	-
Glycerin (Glycerol)	G	G	G	G
Heptane	-	G	G	-
Hexane	-	G	G	-

FLUID	GASKET MATERIAL			
	D	C/N	V	S
Hydraulic Oils	-	G	G	-
Straight Petroleum Base	-	G	G	F
Water Petroleum Emulsion	G	G	G	F
Water Glycol	G	-	F	F
Straight Phosphate Ester	G	-	F	F
Phosphate Ester/Petroleum Blend	-	-	F	-
Ester Blend	G	G	F	F
Silicone Oils	G	G	G	-
Hydrochloric Acid RT	G	F	G	-
Hydrofluoric Acid (48% sol) RT	-	-	G	-
Hydrolube	G	G	G	F
Hydrogen Peroxide (dilute)	F	F	G	G
Hydrogen Peroxide (concentrated)	-	-	F	F
Hydrogen Sulfide (dry) RT	F	F	-	-
Hydrogen Sulfide (wet) RT	F	-	G	-
Hypochlorite Solutions (no free Chlorine)	G	F	G	F
Kerosene RT	-	G	G	-
Linseed Oil	-	G	G	-
Lube Oil (Mineral)	-	G	G	-
Lubricating Oils (Diester Base)	-	F	G	-
Magnesium Salt Solutions	G	G	G	G
Mercuric Chloride	G	G	G	-
Mercury	G	G	G	F
Mineral Oil	-	G	G	G
Naphtha	-	F	G	-
Napthalene	-	-	G	-
Nitric Acid (less than 20%)	F	-	G	-
Oleic Acid	-	G	F	-
Oxalic Acid	G	F	G	F
Oxygen, Gaseous	G	F	G	G
Paraffin	-	G	G	F
Petroleum Oils (Sour or Refined)	-	G	G	-
Phosphoric Acid (Commercial)	G	-	G	-
Potassium Salt Solutions	G	G	G	G
Pydraul C Series, F	F	-	G	F
Pydraul F Series	G	-	-	-
Sodium Salt solutions	G	G	G	F
Steam	F	-	-	-
Sulfur	G	-	-	-
Sulfur Dioxide (wet or dry)	G	-	-	F
Sulfuric Acid (10-75%)	F	-	G	-
Sulfuric Acid (75-95%)	-	-	G	-
Sulfuric Acid (95%) RT	-	-	G	-
Sulfurous Acid	-	F	G	-
Tannic Acid	F	G	F	F
Trichlorethylene	-	-	G	-
Turpentine	-	F	G	-
Vegetable Oils	G	G	G	G
Water (fresh or salt) cold	G	G	G	G
Water (fresh or salt) hot +215° F. max.	G	!!	G	-
Xylene	-	-	G	-
Zinc Salt Solutions	G	G	G	G

!! C maximum +180° F, N maximum +225° F.

How To Order

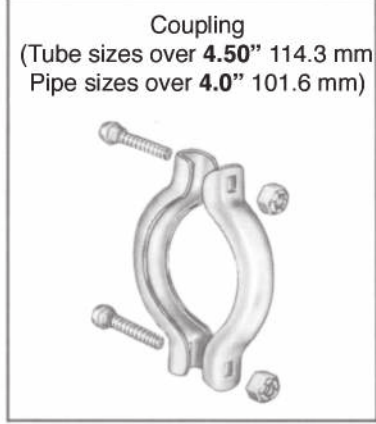
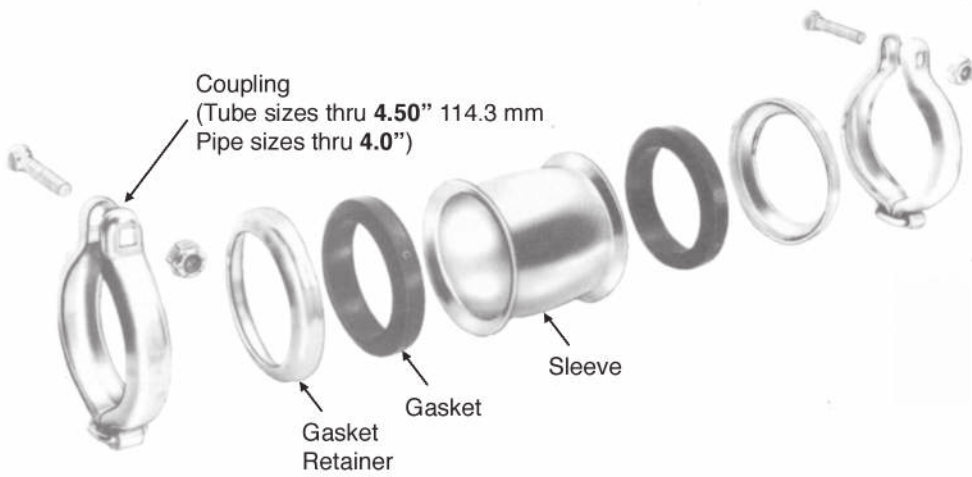

Standard (Un-Restrained) Style

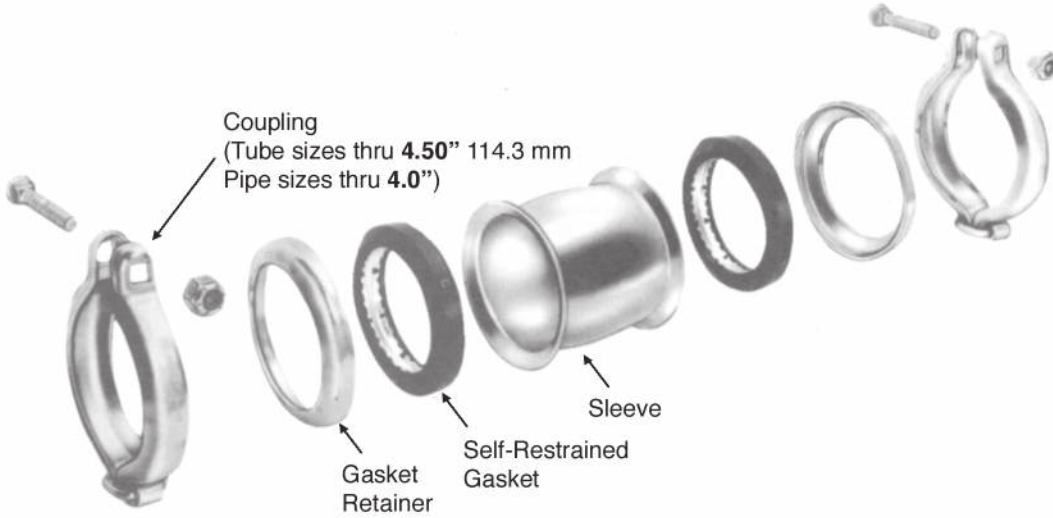

Self-Restrained Style

NH16XX () 000 () 000

Basic Part Number (from pages 10 - 17)

Example: NH1600

Gasket Material:

- C = BUNA-N (standard)
- D = EPDM
- *N = BUNA-N (high temperature)
- *S = Silicone
- *V = Fluorocarbon

* Available in Standard (Un-Restrained) Model Only.

Joint Length (in thousands of inch).

Example: 2.5" = 0250

Style is available in lengths shown. Other lengths are available in multiples of 1-inch on special requests. Contact Eaton for availability.

Sleeve Material:

- B = Plated Steel (Standard)
- S = Stainless Steel (Sleeve only-consult Eaton for availability)

Size of Pipe or Tube to be connected (in hundredths of inch) Example: .75" = 075

Example Part Number: NH1600C075B0250

Complete assemblies may be ordered by the procedure shown above. Standard components may be ordered as shown on page 7.

Technical Data

Parts List

Gasket Material: C – BUNA-N (standard)
 D – EPDM
 N – BUNA-N
 (high temperature)
 V – Fluorocarbon
 S – Silicone

(Other materials available. Consult Eaton.)

COUPLING		STRAIGHT SLEEVES	GASKET RETAINER	GASKETS					Material Available from Stock				
Tube size (inches)	Tube O.D. (inches)	Includes Nut & Bolt Standard	Standard	Standard	Standard Gasket	C	D	N	S	V	Self Restrained Gasket	C	D*
1.00	1.00	NH100085-075YF	NK1237-075B0250	NK1000023-075	NK1000064X100	X	X	X	X	X	NK1000062X100	X	X
1.25	1.25	NH100085-100YF	NK1237-100B0288	NK1000023-100	NK1000064X125	X	X	X	X	X	NK1000062X125	X	X
1.38	1.38	NH100086-150YF	NK1237-138B0300	NK1000056-138	NK1000064X138	X	X	X	X	-			
1.50	1.50	NH100086-150YF	NK1238-150B0300	NK1000056-150	NK1000064X150	X	X	X	X	X	NK1000062X150	X	X
1.75	1.75	NH100085-150YF	NK1238-175B0350	NK1000056-175	NK1000064X175	X	X	X	-	-	NK1000062X175	X	X
2.00	2.00	NH100086-200YF	NK1238-200B0350	NK1000056-200	NK1000064X200	X	X	X	X	X	NK1000062X200	X	X
2.25	2.25	NH100085-200YF	NK1238-225B0400	NK1000056-225	NK1000064X225	X	X	X	-	-			
2.50	2.50	NH100086-250YF	NK1238-250B0400	NK1000056-250	NK1000064X250	X	X	X	X	X	NK1000062X250	X	X
2.88	2.88	NH100085-250YF	NK1237-250B0650	NK1000023-250	NK1000063X250	X	X	X	X	X	NK1000061X250	X	X
3.00	3.00	NH100086-300YF	NK1238-300B0500	NK1000056-300	NK1000064X300	X	X	X	X	X	NK1000062X300	X	X
3.25	3.25	NH100086-325YF	NK1238-325B0650	NK1000056-325	NK1000064X325	X	X	X	-	-			
3.50	3.50	NH100085-300YF	NK1237-300B0650	NK1000023-300	NK1000063X300	X	X	X	X	X	NK1000061X300	X	X
4.00	4.00	NH100085-350YF	NK1237-350B0650	NK1000023-350	NK1000063X350	X	X	X	X	X	NK1000061X350	X	X
4.50	4.50	NH100085-400YF	NK1237-400B0650	NK1000023-400	NK1000063X400	X	X	X	X	X	NK1000061X400	X	X
5.00	5.00	NH100086-500YF	NK1238-500B0650	NK1000056-500	NK1000064X500	X	X	X	-	-	NK1000062X500	X	X
Pipe Size (inches)													
Pipe O.D. (inches)													
.38	.675	NH100085-038YF	NK1237-038B0200	NK1000023-038	NK1000063X038	X	X	X	-	-			
.50	.840	NH100085-050YF	NK1237-050B0225	NK1000023-050	NK1000063X050	X	X	X	X	X	NK1000061X050	X	X
.75	1.050	NH100085-075YF	NK1237-075B0250	NK1000023-075	NK1000063X075	X	X	X	X	X	NK1000061X075	X	X
1.00	1.315	NH100085-100YF	NK1237-100B0288	NK1000023-100	NK1000063X100	X	X	X	X	X	NK1000061X100	X	X
1.25	1.660	NH100085-125YF	NK1237-125B0325	NK1000023-125	NK1000063X125	X	X	X	X	X	NK1000061X125	X	X
1.50	1.900	NH100085-150YF	NK1237-150B0350	NK1000023-150	NK1000063X150	X	X	X	X	X	NK1000061X150	X	X
2.00	2.375	NH100085-200YF	NK1237-200B0400	NK1000023-200	NK1000063X200	X	X	X	X	X	NK1000061X200	X	X
2.50	2.875	NH100085-250YF	NK1237-250B0650	NK1000023-250	NK1000063X250	X	X	X	X	X	NK1000061X250	X	X
3.00	3.500	NH100085-300YF	NK1237-300B0650	NK1000023-300	NK1000063X300	X	X	X	X	X	NK1000061X300	X	X
3.50	4.000	NH100085-350YF	NK1237-B3500650	NK1000023-350	NK1000063X350	X	X	X	X	X	NK1000061X350	X	X
4.00	4.500	NH100085-400YF	NK1237-400B0650	NK1000023-400	NK1000063X400	X	X	X	X	X	NK1000061X400	X	X
5.00	5.563	NH100085-500YF	NK1237-500B0650	NK1000023-500	NK1000063X500	X	X	X	-	X	NK1000061X500	X	X
6.00	6.625	NH100085-600YF	NK1237-600B0650	NK1000023-600	NK1000063X600	X	X	X	X	X	NK1000061X600	X	X

BOLT PART NUMBERS

JOINT SIZE (inches)		BOLT PART NUMBER	NUT PART NUMBER
Tube	Pipe	Carbon Steel	Carbon Steel
.50 to 1.12	.38 to .75	56519A4-7	56535A4C-C
1.25 to 2.50	1 to 2	56519A5-8	56535A5C-C
2.75 to 5	2.50 to 4	56519A6-12	56535A6C-C
6	5 to 6	56519A8-16	56535A8C-C

Assembly Instructions

Pipe and Tubing Preparation and Flexmaster Joint Installation Instructions

1. Pipe (Tube) End Preparation

- Deburr and clean pipe (tube) ends.
- Surface should be free of deep scratches, gouges, dents, dirt, etc.

2. Joint Installation

- Install retainer (1), gasket* (2) and sleeve (3) on one side of pipe in sequence shown in Figure 1.

- Install remaining retainer (4) and gasket (5) on other pipe end.
- Position retainer (4) and gasket (5) to proper pipe insertion depth ("D") as shown in Table 1.
- Slide sleeve (3) to gasket (5) and move gasket (2) and retainer (1) into position as shown in Figure 2. Pipe must be inserted to proper depth ("D") into both gaskets as shown in Table 1.

*3. Special Notes

- Assembly of gaskets can be made easier by dipping gaskets in water or the fluid to be sealed. The use of other rubber lubricants can be detrimental to the life of the gaskets. Never lubricate the metal parts.
- Self-restrained gasket installation. To simplify installation of a self-restrained gasket, install lower gasket halfway onto the pipe first, leaving the split area in the steel retaining ring free at the top. See Figure 3. Then, stretch the gasket and split area of the retaining ring until they slip over the tube or pipe and into position. Refer to Figure 3.

4. Coupler Installation

Install both V-couplings, encompassing the retainer, gasket and sleeve as shown in Figure 4. Do not tighten either coupling until the entire joint is assembled (See Figure 2). Tighten nuts to the torque specified in Table 2. Do NOT lubricate the nut or bolt before assembly. The gap method outline in Table 3 may be used for standard gaskets only.

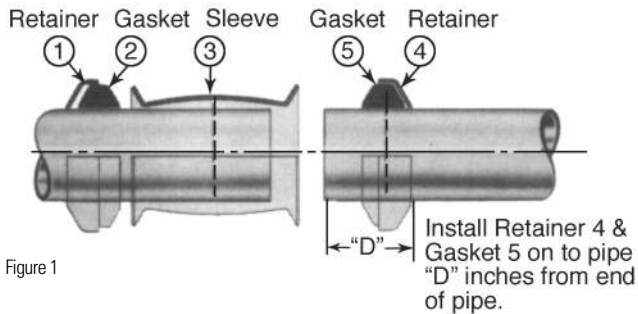

Figure 1

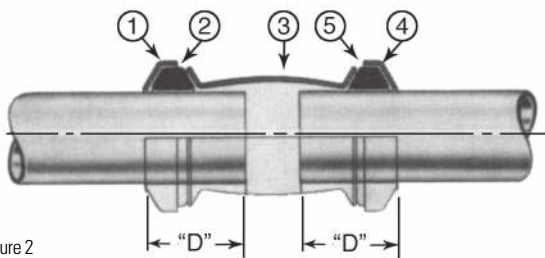
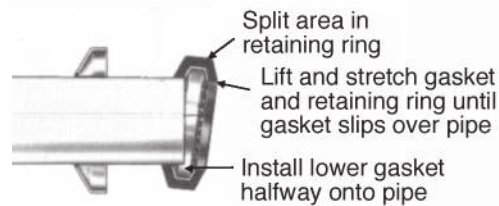
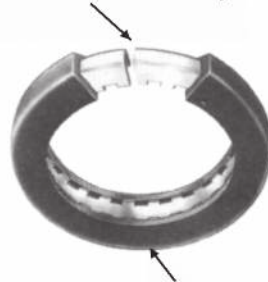

Figure 2



in notched retention ring gasket is shown cut-away for clarity)



Lower gasket and retention ring

Figure 3

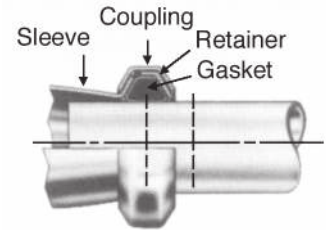

Figure 4



WARNING Maximum temperature ratings are meant as a guide only. For extreme temperature conditions, consult factory. Improper installation, use or selection of the Flexmaster joints can result in personal injury, property damage or death.

Technical Data

TABLE 1. REQUIRED INSERTION DEPTH* OF PIPE AND TUBE

Pipe Pipe Size	"D" min.	"D" max.	Tube Tube Size	"D" min.	"D" max.
.38	.71 18	1.00 25.4	.75 19.1	.74 18.8	1.10 27.9
.50	.71 18	1.09 27.7	.88 22.3	.65 16.5	1.00 25.4
.75	1.00 25.4	1.21 30.7	1.00 25.4	.72 18.3	1.21 30.7
1.00	1.14 29	1.39 35.3	1.12 28.4	.93 23.6	1.21 30.7
1.25	1.15 29.2	1.56 39.6	1.25 31.8	1.16 29.5	1.40 35.6
1.50	1.16 29.5	1.62 41.1	1.38 35.1	1.20 30.5	1.46 37.1
2.00	1.18 30	1.84 46.7	1.50 38.1	1.18 30	1.45 36.8
2.50	1.68 42.7	2.38 60.5	1.75 44.5	1.22 31	1.69 42.9
3.0	1.70 43.2	2.40 61	2.00 50.8	1.15 29.2	1.68 42.7
3.50	1.72 33.7	2.42 61.5	2.25 57.2	1.24 31.5	1.84 46.7
4.00	1.74 44.2	2.44 62	2.38 60.3	1.18 30	1.84 46.7
5.00	2.08 52.8	2.24 56.9	2.50 63.5	1.17 29.7	1.83 46.5
6.00	1.86 47.2	2.33 59.2	2.75 69.9	1.74 44.2	1.90 48.3
			2.88 73.0	1.68 42.7	2.38 60.5
			3.00 76.2	1.67 42.4	2.30 58.4
			3.25 82.6	1.67 42.4	2.48 63
			3.50 88.9	1.70 43.2	2.40 61
			4.00 101.6	1.72 33.7	2.42 61.5
			4.50 114.3	1.74 44.2	2.44 62
			5.00 127	1.75 44.5	2.07 52.6

*Dimensions shown are for standard, straight, bulged sleeves only. Elbow, tees and specials must meet the minimum insertion depths.

NOTE: **inches and inch-lbs in bold**, mm and N•m in light.

TABLE 2. FLEXMASTER JOINT ASSEMBLY TIGHTENING GUIDE. TORQUE METHOD OF INSTALLATION**

Size	Standard	Self-Restrained
.75" to 1.12" Tube (19.1 to 28.4 mm)	40-60 inch-lbs. (4.55-6.88 N•m)	40-60 inch-lbs. (4.55-6.88 N•m)
.38" to .75" Pipe		
1.25" to 2.75" Tube (31.8 to 69.9 mm)	90-100 inch-lbs. (10.14-12.39 N•m)	140-160 inch-lbs. (15.78-18.13 N•m)
1" to 2" Pipe		
2.88" to 3.50" Tube (73 to 88.9 mm)	180-200 inch-lbs. (20.27-22.52 N•m)	220-240 inch-lbs. (24.79-27.14 N•m)
2.50" to 3" Pipe		
4" to 5" Tube (101.6 to 127 mm)	240-260 inch-lbs. (27.14-29.28 N•m)	280-300 inch-lbs. (31.53-33.8 N•m)
3.50" to 4" Pipe		
6" Tube (152.4 mm)	300-360 inch-lbs. (33.8-36.15 N•m)	480-500 inch-lbs. (54.05-56.42 N•m)
5" to 6" Pipe		

**Note: the torque values specified are for an un-lubricated (dry) nut and bolt.

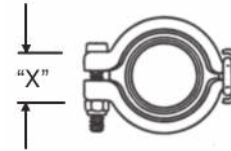
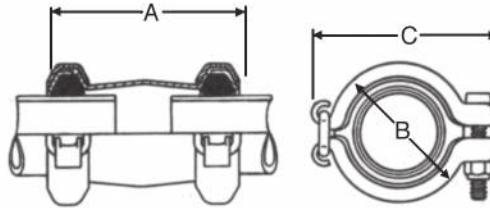

TABLE 3. OPTIONAL CLEARANCE METHOD FOR INSTALLATION OF STANDARD GASKETS.

(Self-restrained gaskets must be installed by Torque Method.)

Tube Size	Pipe Size	Dimension X ±.06
.50, .63, .75 12.7, 16.0, 19.1	$\frac{3}{8}, \frac{1}{2}$.62 15.8
1.00, 1.13 25.4, 28.7	$\frac{3}{4}$.69 17.5
1.25, 1.38 31.8, 35.1	1	.94 23.9
1.50, 1.75 38.1, 44.5	$1 \frac{1}{4}$.94 23.9
	$1 \frac{1}{2}$.94 23.9
2.25 57.2	2	.88 22.4
2.50, 2.75 63.5, 69.9	$2 \frac{1}{2}$	1.50 38.1
3.00, 3.25 76.2, 82.6	3	1.56 39.6
	$3 \frac{1}{2}$	1.56 39.6
	4	1.56 39.6
5.00, 6.00 127, 152.4	5, 6	Use Torque Method

Joins for Rigid Pipe



Basic Part Number: NH1600
NH1650
Allowable misalignment: $\pm 4'$ per end

PIPE SIZE	PIPE O.D.	B	C	STRAIGHT PART NUMBER*	A
.38	.675	1.48	2.34	**NH1600X038X0200	2.00
	17.1	37.6	59.4	-	50.8
.50	.840	1.65	2.53	NH1600X050X0225	2.25
	21.3	41.9	64.3	NH1650X050X0225	57.2
.75	1.050	1.86	2.75	NH1600X075X0250	2.50
	26.7	47.2	69.9	NH1650X075X0250	63.5
1.00	1.315	2.37	3.48	NH1600X100X0288	2.88
	33.4	60.2	88.4	NH1650X100X0288	73.2
1.25	1.660	2.71	3.85	NH1600X125X0325	3.25
	42.2	68.8	97.8	NH1650X125X0325	82.6
1.50	1.900	2.96	4.11	NH1600X150X0350	3.50
	48.3	75.2	104.4	NH1650X150X0350	88.9
2.00	2.375	3.43	4.60	NH1600X200X0400	4.00
	60.3	87.1	116.8	NH1650X200X0400	101.6
2.50	2.875	4.73	6.23	NH1600X250X0650	6.50
	73.0	120.1	158.2	NH1650X250X0650	165.1
3.00	3.500	5.36	6.87	NH1600X300X0650	6.50
	88.9	136.1	174.5	NH1650X300X0650	165.1
3.50	4.000	5.86	7.38	NH1600X350X0650	6.50
	101.6	148.8	187.5	NH1650X350X0650	165.1
4.00	4.500	6.36	7.89	NH1600X400X0650	6.50
	114.3	161.5	200.5	NH1650X400X0650	165.1
5.00	5.563	8.22	10.62	**NH1600X500X0650	6.50
	141.4	208.8	269.7	NH1650X500X0650	165.1
6.00	6.625	8.86	11.24	**NH1600X600X0650	6.50
	168.3	225.0	285.5	NH1650X600X0650	165.1

Note: Letter X in part numbers shown indicates a code letter to be filled in. See Page 6 for explanation of part numbers and how to order.

* Gray part numbers are standard type. Black part numbers are self-restrained type.

** Sleeve in this size is cylindrical (no-bulge). Allowable misalignment is $\pm 2'$ per end for this size.

Dimensions: **inches in bold**, mm in light

Joins for Rigid Pipe

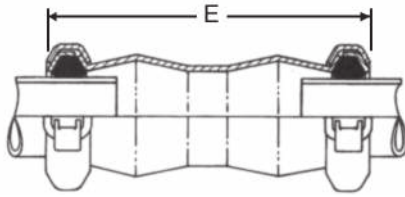

Basic Part Number: NH1600 (Long)
NH1650 (Long)
Allowable misalignment: $\pm 4^\circ$ per end

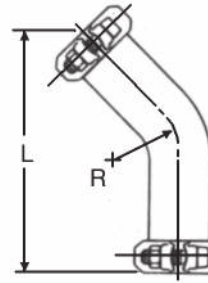

Basic Part Number: NH1601
NH1651
Allowable misalignment: $\pm 2^\circ$ per end

PIPE SIZE	PIPE O.D.	STRAIGHT DOUBLE-BULGED PART NUMBER*	E†	45° LONG ELBOW PART NUMBER*	L		R	
					L	R		
.38	.675 17.1	**NH1600X038X0200	2.00	NH1601X038X	4.16	.88		
		-	50.8	-	105.7	22.3		
.50	.840 21.3	NH1600X050X0350	3.50	NH1601X050X	4.37	1.06		
		NH1650X050X0350	88.9	NH1651X050X	111.0	26.9		
.75	1.050 26.7	NH1600X075X0400	4.00	NH1601X075X	5.33	1.31		
		NH1650X075X0400	101.6	NH1651X075X	135.4	34.3		
1.00	1.315 33.4	NH1600X100X0450	4.50	NH1601X100X	5.77	1.62		
		NH1650X100X0450	114.3	NH1651X100X	146.6	41.1		
1.25	1.66 42.2	NH1600X125X0550	5.50	NH1601X125X	5.97	1.88		
		NH1650X125X0550	139.7	NH1651X125X	151.6	47.8		
1.50	1.900 48.3	NH1600X150X0575	5.75	NH1601X150X	6.18	2.12		
		NH1650X150X0575	146.1	NH1651X150X	157.0	53.8		
2.00	2.375 60.3	NH1600X200X0675	6.75	NH1601X200X	6.40	2.62		
		NH1650X200X0675	171.5	NH1651X200X	162.6	66.5		
2.50	2.875 73.0	NH1600X250X1125	11.25	NH1601X250X	7.26	3.25		
		NH1650X250X1125	285.8	NH1651X250X	184.3	82.6		
3.00	3.500 88.9	NH1600X300X1125	11.25	NH1601X300X	8.54	5.00		
		NH1650X300X1125	285.8	NH1651X300X	216.9	127.0		
3.50	4.000 101.6	NH1600X350X1125	11.25	NH1601X350X	9.18	6.00		
		NH1650X350X1125	285.8	NH1651X350X	233.1	152.4		
4.00	4.500 114.3	NH1600X400X1125	11.25	NH1601X400X	9.82	7.00		
		NH1650X400X1125	285.8	NH1651X400X	249.4	177.8		
5.00	5.563 141.4	NH1600X500X0650	6.50					
		NH1650X500X0650	165.1					
6.00	6.625 168.3	NH1600X600X0650	6.50					
		NH1650X500X0650	165.1					

Note: Letter X in part numbers shown indicates a code letter to be filled in. See Page 6 for explanation of part numbers and how to order.

*Gray part numbers are standard type. Black part numbers are self-restrained type.

** Sleeve in this size is cylindrical (no-bulge). Allowable misalignment is $\pm 2^\circ$ per end for this size.

† Straight, Double-Bulged joints are available in longer lengths than "E" shown in increments of 1 inch. Consult Eaton. "E" dimension is minimum length for longer joints

Dimensions: **inches in bold**, mm in light.

Joins for Rigid Pipe

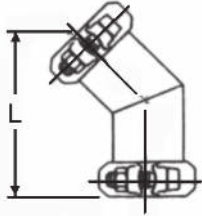

Basic part number: NH1617
NH1667
Allowable misalignment: $\pm 2'$ per end

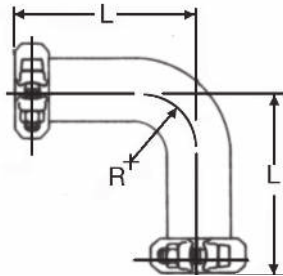

Basic Part Number: NH1602
NH1652
Allowable misalignment: $\pm 2'$ per end

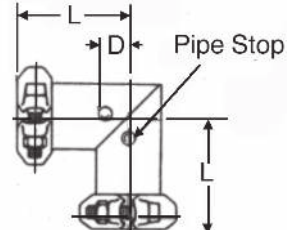

Basic Part Number: NH1618
NH1668
Allowable misalignment: $\pm 2'$ per end

PIPE SIZE	45° SHORT ELBOW PART NUMBER*	L	90° LONG ELBOW PART NUMBER*		90° SHORT ELBOW PART NUMBER*			
			L	R	L	D		
.38	NH1617X038X	2.56	NH1602X038X	2.44	.88	NH1618X038X	1.88	.38
	-	65.0	-	62.0	22.3	-	47.8	9.7
.50	NH1617X050X	2.99	NH1602X050X	2.56	1.06	NH1618X050X	2.03	.46
	NH1667X050X	75.9	NH1652X050X	65.0	26.9	NH1668X050X	51.6	10.7
.75	NH1617X075X	3.41	NH1602X075X	3.88	1.31	NH1618X075X	2.31	.56
	NH1667X075X	86.6	NH1652X075X	98.6	34.3	NH1668X075X	58.7	14.2
1.00	NH1617X100X	3.89	NH1602X100X	4.25	1.62	NH1618X100X	2.69	.72
	NH1667X100X	98.8	NH1652X100X	108.0	41.1	NH1668X100X	68.3	18.3
1.25	NH1617X125X	4.42	NH1602X125X	4.50	1.88	NH1618X125X	3.09	.88
	NH1667X125X	112.3	NH1652X125X	114.3	47.8	NH1668X125X	78.5	22.3
1.50	NH1617X150X	4.85	NH1602X150X	4.88	2.12	NH1618X150X	3.41	1.00
	NH1667X150X	123.2	NH1652X150X	124.0	53.8	NH1668X150X	86.6	25.4
2.00	NH1617X200X	5.55	NH1602X200X	5.38	2.62	NH1618X200X	3.97	1.25
	NH1667X200X	141.0	NH1652X200X	136.7	66.5	NH1668X200X	100.8	31.8
2.50	NH1617X250X	5.97	NH1602X250X	6.12	3.25	NH1618X250X	4.62	1.56
	NH1667X250X	151.6	NH1652X250X	155.4	82.6	NH1668X250X	117.3	39.6
3.00	NH1617X300X	6.40	NH1602X300X	8.06	5.00	NH1618X300X	5.00	1.88
	NH1667X300X	162.6	NH1652X300X	204.7	127.0	NH1668X300X	127.0	47.8
3.50	NH1617X350X	6.83	NH1602X350X	9.06	6.00	NH1618X350X	52.5	2.19
	NH1667X350X	173.5	NH1652X350X	230.1	152.4	NH1668X350X	133.4	55.6
4.00	NH1617X400X	7.26	NH1602X400X	10.06	7.00	NH1618X400X	5.50	2.44
	NH1667X400X	184.4	NH1652X400X	255.5	177.8	NH1668X400X	139.7	62.0

Note: Letter X in part numbers shown indicates a code letter to be filled in.

See Page 6 for explanation of part numbers and how to order.

*Gray part numbers are standard type. Black part numbers are self-restrained type.

Dimensions: **inches in bold**, mm in light

Joins for Rigid Pipe

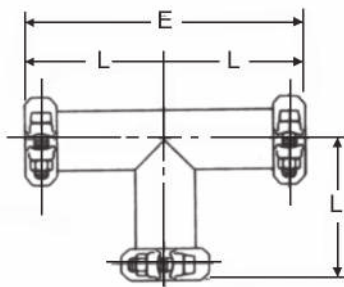

Basic Part Number: NH1604
NH1654
Allowable misalignment: $\pm 2'$ per end

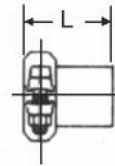

Basic Part Number NH1606
NH1656
Allowable misalignment: $\pm 2'$ per end

PIPE SIZE	TEE PART NUMBER*	L	E	BULKHEAD JOINT PART NUMBER*	MIN. L
.38	NH1604X038X	2.25	4.50	NH1606X038X	1.75
	-	57.2	114.3	-	45.1
.50	NH1604X050X	2.50	5.00	NH1606X050X	1.75
	NH1654X050X	63.5	127.0	NH1656X050X	45.1
.75	NH1604X075X	2.88	5.76	NH1606X075X	2.25
	NH1654X075X	73.5	146.3	NH1656X075X	57.2
1.00	NH1604X100X	3.50	7.00	NH1606X100X	2.50
	NH1654X100X	88.9	177.8	NH1656X100X	63.5
1.25	NH1604X125X	4.12	8.24	NH1606X125X	2.62
	NH1654X125X	104.6	209.3	NH1656X125X	66.5
1.50	NH1604X150X	4.50	9.00	NH1606X150X	2.88
	NH1654X150X	114.3	228.6	NH1656X150X	73.2
2.00	NH1604X200X	5.25	10.50	NH1606X200X	3.38
	NH1654X200X	133.4	266.7	NH1656X200X	85.9
2.50	NH1604X250X	6.94	13.88	NH1606X250X	4.00
	NH1654X250X	176.3	352.6	NH1656X250X	101.6
3.00	NH1604X300X	7.94	15.88	NH1606X300X	4.00
	NH1654X300X	201.7	403.4	NH1656X300X	101.6
3.50	NH1604X350X	8.69	17.38	NH1606X350X	4.00
	NH1654X350X	220.7	441.5	NH1656X350X	101.6
4.00	NH1604X400X	9.44	18.88	NH1606X400X	4.00
	NH1654X400X	239.8	479.6	NH1656X400X	101.6

Note: Letter X in part numbers shown indicates a code letter to be filled in.

See Page 6 for explanation of part numbers and how to order.

*Gray part numbers are standard type. Black part numbers are self-restrained type.

Dimensions: **inches in bold**, mm in light

Joins for Inch-Size Tube

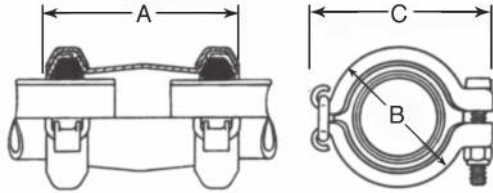

Basic part number: NH1625
NH1675
Allowable misalignment: $\pm 4'$ per end

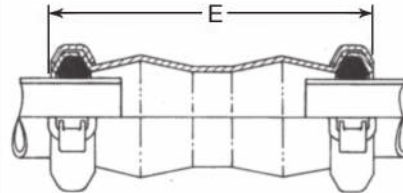

Basic Part Number NH1625 (Long)
NH1675 (Long)
Allowable misalignment: $\pm 2'$ per end

TUBE SIZE	B	C	STRAIGHT PART NUMBER*	A	STRAIGHT DOUBLE-BULGED PART NUMBER*	E†
.75 19.1	1.65 41.9	2.53 64.3	NH1625X075X0225 -	2.25 57.2	NH1625X075X0350 -	3.50 88.9
.88 22.2	1.65 41.9	2.53 64.3	NH1625X088X0225 -	2.25 57.2	NH1625X088X0350 -	3.50 88.9
1.00 25.4	1.86 47.2	2.75 69.9	NH1625X100X0250 NH1675X100X0250	2.50 63.5	NH1625X100X0400 NH1675X100X0400	4.00 101.6
1.12 28.6	1.86 47.2	2.75 69.9	NH1625X112X0250 -	2.50 63.5	NH1625X112X0450 -	4.50 114.3
1.25 31.8	2.37 60.2	3.48 88.4	NH1625X125X0288 NH1675X125X0288	2.88 73.2	NH1625X125X0450 NH1675X125X0450	4.50 114.3
1.38 34.9	2.55 64.8	3.68 93.5	NH1625X138X0300 NH1675X138X0300	3.00 76.2	NH1625X138X0475 NH1675X138X0475	4.75 120.7
1.50 38.1	2.55 64.8	3.68 93.5	NH1625X150X0300 NH1675X150X0300	3.00 76.2	NH1625X150X0475 NH1675X150X0475	4.75 120.7
1.75 44.5	2.96 75.2	4.11 104.4	NH1625X175X0350 NH1675X175X0350	3.50 88.9	NH1625X175X0575 NH1675X175X0575	5.75 146.1
2.00 50.8	3.06 77.7	4.20 106.7	NH1625X200X0350 NH1675X200X0350	3.50 88.9	NH1625X200X0575 NH1675X200X0575	5.75 146.1
2.25 54.9	3.43 87.1	4.60 116.8	NH1625X225X0400 -	4.00 101.6	NH1625X225X0675 -	6.75 171.5
2.38 60.3	3.43 87.1	4.60 116.8	NH1600X200X0400 NH1650X200X0400	4.00 101.6	NH1600X200X0675 NH1650X200X0675	6.75 171.5
2.50 63.5	3.55 90.2	4.72 133.9	NH1625X250X0400 NH1675X250X0400	4.00 101.6	NH1625X250X0675 NH1675X250X0675	6.75 171.5
2.75 69.9	4.73 120.1	6.23 158.2	NH1625X275X0400 -	4.00 101.6	NH1625X275X0675 -	6.75 171.5
2.88 73.0	4.73 120.1	6.23 158.2	NH1600X250X0650 NH1650X250X0650	6.50 165.1	NH1600X250X1125 NH1650X250X1125	11.25 285.8
3.00 76.2	4.86 123.4	6.34 161.0	NH1625X300X0500 NH1675X300X0500	5.00 127.0	NH1625X300X1125 NH1675X300X1125	11.25 285.8
3.25 86.6	5.11 129.8	6.60 167.7	NH1625X325X0650 -	6.50 165.1	NH1625X325X1125 -	11.25 285.8
3.50 88.9	5.36 136.1	6.87 174.5	NH1600X300X0650 NH1650X300X0650	6.50 165.1	NH1600X300X1125 NH1650X300X1125	11.25 285.8
4.00 101.6	5.86 148.8	7.38 187.5	NH1600X350X0650 NH1650X350X0650	6.50 165.1	NH1600X350X1125 NH1650X350X1125	11.25 285.8
4.50 114.3	6.36 161.5	7.89 200.5	NH1600X400X0650 NH1650X400X0650	6.50 165.1	NH1600X400X1125 NH1650X400X1125	11.25 285.8
5.00 127.0	6.86 174.2	8.76 222.5	**NH1625X500X0650 NH1675X500X0450	6.50 165.1	***NH1625X500X0650 NH1675X500X0450	6.50 165.1

Note: Letter X in part numbers shown indicates a code letter to be filled in.
See Page 6 for explanation of part numbers and how to order.

*Gray part numbers are standard type. Black part numbers are self-restrained type.

Dimensions: **inches in bold**, mm in light

**Sleeve in this size is cylindrical (unbulged). Allowable misalignment for this size is $\pm 2'$ per end.

† Straight, Double-Bulged joints are available in longer lengths than "E" shown in increments of 1 inch. "E" dimension is **minimum length** for longer joints.

Joins for Inch-Size Tube

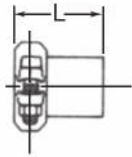

Basic part number: **NH1631**
NH1681
Allowable misalignment: $\pm 2'$ per end

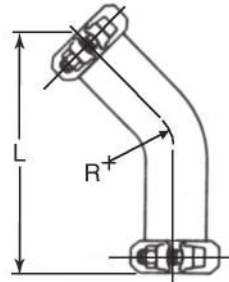

Basic Part Number **NH1626 (Long)**
NH1676 (Long)
Allowable misalignment: $\pm 2'$ per end

TUBE SIZE	BULKHEAD JOINT PART NUMBER*	MIN. L	45° ELBOW PART NUMBER*	L	R
.75	-	-	-	-	-
19.1	-	-	-	-	-
.88	-	-	-	-	-
22.2	-	-	-	-	-
1.00	NH1631X100X	2.25	NH1626X100X	5.33	1.31
25.4	NH1681X100X	57.2	NH1676X100X	140.5	34.3
1.12	-	-	-	-	-
28.6	-	-	-	-	-
1.25	NH1631X125X	2.50	NH1626X125X	5.77	1.62
31.8	NH1681X125X	6.35	NH1676X125X	146.6	41.1
1.38	NH1631X138X	2.62	NH1626X138X	5.97	1.75
34.9	NH1681X138X	6.65	NH1676X138X	151.6	44.5
1.50	NH1631X150X	2.62	NH1626X150X	5.97	1.75
38.1	NH1681X150X	6.65	NH1676X150X	151.6	44.5
1.75	-	-	-	-	-
44.5	-	-	-	-	-
2.00	NH1631X200X	2.88	NH1626X200X	6.30	2.25
50.8	NH1681X200X	73.2	NH1676X200X	160.0	57.2
2.25	-	-	-	-	-
54.9	-	-	-	-	-
2.38	-	-	-	-	-
60.3	-	-	-	-	-
2.50	NH1631X250X	3.38	NH1626X250X	6.62	2.75
63.5	NH1681X250X	85.9	NH1676X250X	168.1	69.9
2.75	-	-	-	-	-
69.9	-	-	-	-	-
2.88	-	-	-	-	-
73.0	-	-	-	-	-
3.00	NH1631X300X	4.00	NH1626X300X	7.68	3.38
76.2	NH1681X300X	101.6	NH1676X300X	195.1	85.9
3.25	-	-	-	-	-
86.6	-	-	-	-	-
3.50	NH1606X300X	4.00	NH1601X300X	8.54	5.00
88.9	NH1656X300X	101.6	NH1651X300X	216.9	127.0
4.00	NH1606X350X	4.00	NH1601X350X	9.18	6.00
101.6	NH1656X350X	101.6	NH1651X350X	233.1	152.4
4.50	NH1606X400X	4.00	NH1601X400X	9.82	7.00
114.3	NH1656X400X	101.6	NH1651X400X	249.4	177.8
5.00	NH1631X500X	4.00	-	-	-
127.0	NH1681X500X	101.6	-	-	-

Dimensions: **inches in bold**, mm in light

Note: Letter X in part numbers shown indicates a code letter to be filled in.

See Page 6 for explanation of part numbers and how to order.

*Gray part numbers are standard type. Black part numbers are self-restrained type.

Joins for Inch-Size Tube

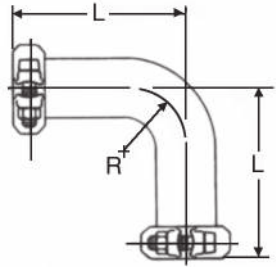

Basic part number: NH1627
NH1677
Allowable misalignment: $\pm 2^\circ$ per end

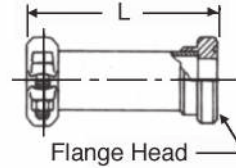

Basic Part Number NH1635
NH1685
Allowable misalignment: $\pm 2^\circ$ per end

TUBE SIZE	90° ELBOW PART NUMBER*	L	R	SAE FLANGE HEAD SIZE	STRAIGHT PART NUMBER*	L
.75 19.1	NH1627X075X -	2.62 66.5	1.06 26.9	- -	- -	- -
1.00 25.4	NH1627X100X NH1677X100X	3.88 98.6	1.31 34.3	1.00 25.4	NH1635X100 NH1685X100	3.56 90.4
- -	- -	- -	- -	1.25 31.8	NH1635X100-125 NH1685X100-125	3.56 90.4
1.25 31.8	NH1627X125X NH1677X125X	4.25 108.0	- -	1.25 31.8	NH1635X125 NH1685X125	3.69 93.7
- -	- -	- -	- -	1.50 38.1	NH1635X125-150 NH1685X125-150	3.75 95.3
1.38 34.9	NH1627X138X NH1677X138X	4.50 114.3	1.75 44.5	1.25 31.8	NH1635X138-125 NH1685X138-125	3.69 93.7
1.50 38.1	NH1627X150X NH1677X150X	4.50 114.3	1.75 44.5	1.50 38.1	NH1635X150 NH1685X150	3.75 95.3
- -	- -	- -	- -	2.00 50.8	NH1635X150-200 NH1685X150-200	3.75 95.3
1.75 44.5	NH1627X175X NH1677X175X	5.00 127.0	2.25 54.9	- -	- -	- -
2.00 50.8	NH1627X200X NH1677X200X	5.00 127.0	2.25 54.9	2.00 50.8	NH1635X200 NH1685X200	4.25 108.0
- -	- -	- -	- -	2.50 63.5	NH1635X200-250 NH1685X200-250	4.31 109.5
2.50 63.5	NH1627X250X NH1677X250X	5.62 142.7	2.75 69.9	2.50 63.5	NH1635X250 NH1685X250	4.31 109.5
- -	- -	- -	- -	- -	NH1635X250-300 NH1685X250-300	4.38 111.3
3.00 76.2	NH1627X300X NH1677X300X	6.44 164.6	3.38 85.9	3.00 76.2	NH1635X300 NH1685X300	4.75 120.7
3.50 88.9	NH1627X350X NH1677X350X	8.06 104.7	5.00 127.0	- -	- -	- -
4.00 101.6	NH1627X400X NH1677X400X	9.06 130.1	6.00 152.4	4.00 101.6	NH1635X400 NH1685X400	5.87 149.1
4.50 114.3	NH1627X450X NH1677X450X	10.6 155.5	7.00 177.8	- -	- -	- -

Dimensions: **inches in bold**, mm in light

Note: Letter X in part numbers shown indicates a code letter to be filled in. See Page 6 for explanation of part numbers and how to order.

*Gray part numbers are standard type. Black part numbers are self-restrained type.

Flexmaster flanged and threaded styles shown on this page are not normally stock items and are not available in stainless steel. Consult Eaton for delivery.

Joins for Inch-Size Tube

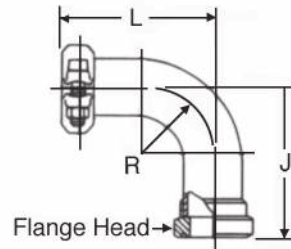

Basic part number: **NH1637**
NH1687
 Allowable misalignment: $\pm 2'$ per end

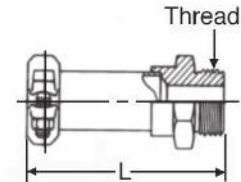

Basic Part Number **NH1641**
NH1691
 Allowable misalignment: $\pm 2'$ per end

TUBE SIZE	90° ELBOW PART NUMBER*	L	J	R	THREAD NPTF	STRAIGHT PART NUMBER* L	
							L
1.00	NH1637X100	3.88	2.38	1.31	1-11 1/2	NH1641X100	3.28
25.4	NH1687X100	98.6	60.5	33.3	-	NH1691X100	83.3
-	NH1637X100-125	3.88	2.38	1.31	-	-	-
-	NH1687X100-125	98.6	60.5	33.3	-	-	-
1.25	NH1637X125	4.25	2.50	1.62	1 1/4 - 11 1/2	NH1641X125	3.62
31.8	NH1687X125	108.0	63.5	41.1	-	NH1691X125	91.9
-	NH1637X125-150	4.25	2.56	16.2	-	-	-
-	NH1687X125-150	108.0	65.0	41.1	-	-	-
1.38	-	-	-	-	-	-	-
34.9	-	-	-	-	-	-	-
1.50	NH1637X150	4.50	2.75	1.75	1 1/2 - 11 1/2	NH1641X150	3.78
38.1	NH1687X150	113.9	69.9	44.5	-	NH1691X150	96.0
-	NH1637X150-200	4.50	2.75	1.75	-	-	-
-	NH1687X150-200	113.9	69.9	44.5	-	-	-
2.00	NH1637X200	5.12	3.25	2.25	-	NH1641X200	4.06
50.8	NH1687X200	130.0	82.6	57.2	-	NH1691X200	103.1
-	NH1637X200-250	5.12	3.31	2.25	-	-	-
-	NH1687X200-250	130.0	85.1	57.2	-	-	-
2.50	NH1637X250	5.62	3.75	2.75	2 1/2 - 8	NH1641X250	4.30
63.5	NH1687X250	142.7	95.3	69.9	-	NH1691X250	109.2
-	NH1637X250-300	5.62	3.81	2.75	-	-	-
-	NH1687X250-300	142.7	96.8	69.9	-	-	-
3.00	NH1637X300	6.50	4.25	3.38	-	-	-
76.2	NH1687X300	165.1	108.0	85.9	-	-	-
3.50	-	-	-	-	-	-	-
88.9	-	-	-	-	-	-	-
4.00	NH1637X400	9.06	7.50	6.00	-	-	-
101.6	NH1687X400	130.1	190.5	152.4	-	-	-
4.50	-	-	-	-	-	-	-
114.3	-	-	-	-	-	-	-

Dimensions: **inches in bold**, mm in light

Note: Letter X in part numbers shown indicates a code letter to be filled in. See Page 6 for explanation of part numbers and how to order.

*Gray part numbers are standard type. Black part numbers are self-restrained type.

Flexmaster flanged and threaded styles shown on this page are not normally stock items and are not available in stainless steel. Consult Eaton for delivery.

Eaton
14615 Lone Oak Road
Eden Prairie, MN 55344
USA
Tel: 952 937-9800
Fax: 952 974-7722
www.hydraulics.eaton.com

Eaton
20 Rosamond Road
Footscray
Victoria 3011
Australia
Tel: (61) 3 9319 8222
Fax: (61) 3 9318 5714

Eaton
Dr.-Reckeweg-Str. 1
D-76532 Baden-Baden
Germany
Tel: (49) 7221 682-0
Fax: (49) 7221 682-788

